



www.genswiss.com  
sales@genswiss.com  
1-413-562-4800

# Signature Series Ejector Pins

For CITIZEN, STAR, & TSUGAMI Machines



\*Kit EJK-CIT2532-KIT-A Shown

## Standard Machining Applications

Interchangeable Tips With High Pressure Air Or Coolant-Thru

Stand-Alone Ejector Pins

Assorted Kits Idea For 1 Machine

Base & Tip Packs Ideal For Multiple Machines

## Cut Down On Cost & Reduce Operation Time

### Multiple Tip Sizes For Different Collet Types & Sizes

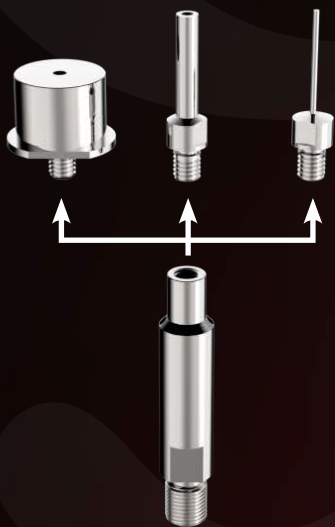

### High Pressure Air Or Coolant

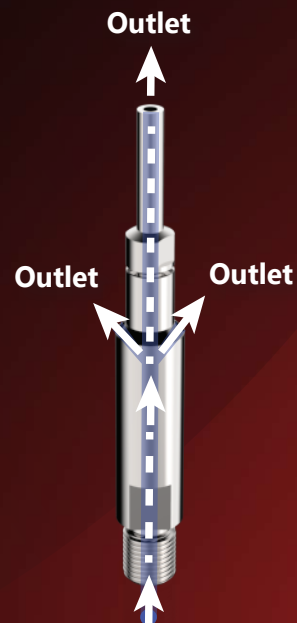

CITIZEN 12, 16, 20, 25, & 32mm Machine Kits  
STAR 16, 20, 25, & 32mm Machine Kits  
TSUGAMI 12, 16, & 20mm Machine Kits

Inlet For High Pressure Air Or Coolant Inlet

## CITIZEN 12mm Machines

Item No.	Kit	Machines	Component Type	Diameter	Length	Coolant-Thru
7512-000128	EJK-CIT12-KIT-A	Citizen K12, L12	Ejector Base	.160in	1.550in	No
				.310in	1.550in	Yes
			Interchangeable Tips	.040in	0.850in	No
				.060in	0.850in	No
				.090in	0.850in	No
				.120in	0.850in	No
				.040in	1.034in	No
				.093in	1.034in	Yes
				.200in	1.034in	Yes
				.310in	1.034in	Yes

### 12mm Machines



M5  
Female

**Ejector Base**  
M5 Male 10-32 Female

**Ejector Base**  
M5 Male 4-48 Female

**Interchangeable Tips**  
10-32 Male

**Interchangeable Tips**  
4-48 Male

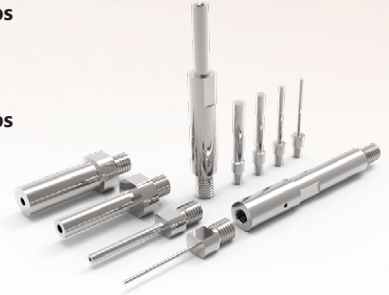

## CITIZEN 16 & 20mm Machines

Item No.	Kit	Machines	Component Type	Diameter	Length	Coolant-Thru
7512-000124	EJK-CIT1620-KIT-A	Citizen C16, A20, L20, M20	Ejector Base	.276in	1.600in	Yes
				.625in	0.500in	Yes
			Interchangeable Tips	.040in	1.034in	No
				.070in	1.034in	No
				.093in	1.034in	Yes
				.200in	1.034in	Yes
				.120in	1.600in	No
				.240in	1.600in	Yes
			Stand-Alone Ejectors	.300in	1.600in	Yes
				.394in	1.600in	Yes

### 16 & 20mm Machines



M8  
Female

**Ejector Base**  
M8 Male 10-32 Female

**Stand-Alone Ejector Pin**  
M8 Male

**Interchangeable Tips**  
10-32 Male



## CITIZEN 25 & 32mm Machines

Item No.	Kit	Machines	Component Type	Diameter	Length	Coolant-Thru
7512-000125	EJK-CIT2532-KIT-A	Citizen L25, A32, L32, M32	Ejector Base	.276in	1.600in	Yes
				.625in	0.500in	Yes
			Interchangeable Tips	.040in	1.034in	No
				.070in	1.034in	No
				.093in	1.034in	Yes
				.200in	1.034in	Yes
				.120in	1.600in	No
			Stand-Alone Ejectors	.240in	1.600in	Yes
				.300in	1.600in	Yes
				.394in	1.600in	Yes
			Adapter M10-M8	.394in	0.800in	Yes

### 25 & 32mm Machines



M10  
Female

**Ejector Base**  
M10 Male 10-32 Female

**Adapter**  
M10 Male M8 Female → M8 Male

**Interchangeable Tips**  
10-32 Male

**Stand-Alone Ejector Pin**



## STAR 16, 20, 25, & 32mm Machines

Item No.	Kit	Machines	Component Type	Diameter	Length	Coolant-Thru
7512-000139	EJK-STA1632-KIT-A	Star	Ejector Base	.275in	1.571in	Yes
			Interchangeable Tips	.093in	1.034in	No
				.093in	1.034in	Yes
				.150in	1.034in	Yes
				.250in	1.034in	Yes
				.310in	1.034in	Yes
				.375in	1.034in	No
				.375in	1.034in	Yes
				.437in	1.034in	No
				.437in	1.034in	Yes

### 16, 20, 25, & 32mm Machines

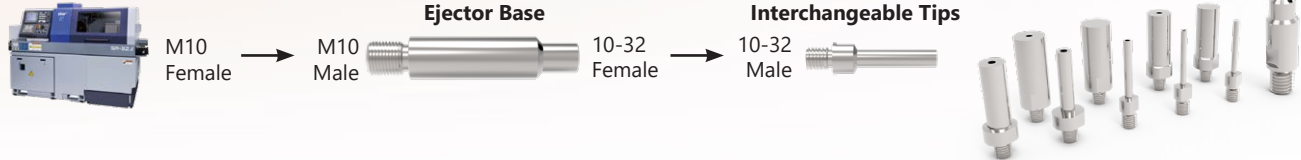

## TSUGAMI 12mm Machines

Item No.	Kit	Machines	Component Type	Diameter	Length	Coolant-Thru
7512-000141	EJK-TSU12-KIT-A	Tugami	Ejector Base	.276in	0.8in	Yes
			Interchangeable Tips	.093in	1.034in	No
				.120in	1.034in	Yes
				.200in	1.034in	Yes
				.310in	1.034in	Yes
				.375in	1.034in	Yes
				.437in	1.034in	No
				.437in	1.034in	Yes

### 12mm Machines

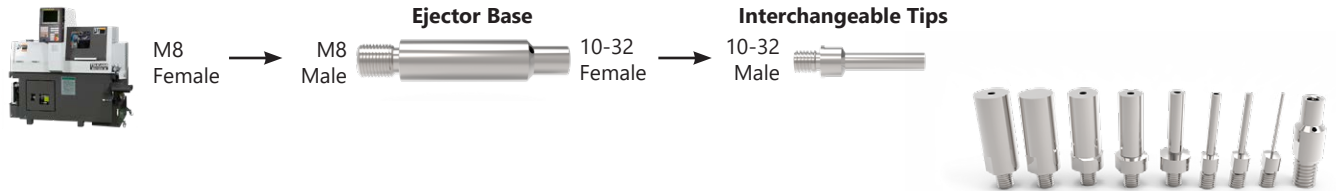

## TSUGAMI 16 & 20mm Machines

Item No.	Kit	Machines	Component Type	Diameter	Length	Coolant-Thru
7512-000140	EJK-TSU1620-KIT-A	Tugami	Ejector Base	.276in	0.8in	Yes
			Interchangeable Tips	.093in	1.034in	No
				.093in	1.034in	Yes
				.150in	1.034in	Yes
				.250in	1.034in	Yes
				.310in	1.034in	Yes
				.375in	1.034in	No
				.375in	1.034in	Yes
				.437in	1.034in	No
				.437in	1.034in	Yes

### 16mm & 20mm Machines

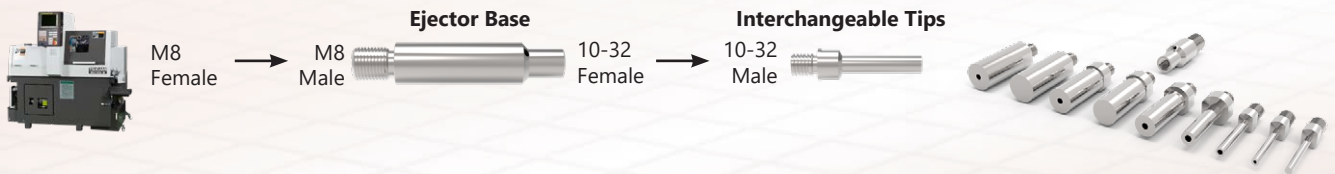

## Stand-Alone Ejector Pin Kit

Item No.	Kit	Machines	Diameter	Length	Coolant-Thru
7512-000136	EJK-M8-KIT-A	Citizen	.120in	1.600in	No
		C16, A20, L20, M20, L25, A32, L32, M32	.240in	1.600in	Yes
			.300in	1.600in	Yes
			.394in	1.600in	Yes

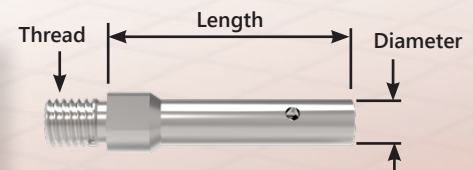

## Ejector Base Packs

Machine(s)	Pieces	Coolant-Thru	Fits Ejector Tips	Item No.	Pack No.
TSUGAMI 12, 16, 20mm	4	Yes	10-32	7512-000149	EJK-PACKBASE-M8-1032-080-IC
STAR 12, 16, 20, 32mm	4	Yes	10-32	7512-000150	EJK-PACKBASE-M10-1032-157-IC
CITIZEN 12mm	4	Yes	10-32	7512-000151	EJK-PACKBASE-M5-1032-155-IC
CITIZEN 12mm	4	Yes	4-48	7512-000152	EJK-PACKBASE-M5-448-155-IC*
CITIZEN 16, 20mm	4	Yes	10-32	7512-000153	EJK-PACKBASE-M8-1032-160-IC
CITIZEN 25, 32mm	4	Yes	10-32	7512-000154	EJK-PACKBASE-M10-1032-160-IC

\*Requires tips from kit EJK-CIT12-KIT-A or kit EJK-0448-KIT-A

## Tip Packs - Includes 5 Pieces Of A Single Size

Pieces	Diameter	Length	Coolant-Thru	Thread	Item No.	Pack No.
5	.040in	1.034in	No	10-32	7512-000163	EJK-PACKTIP-1032-1034-040
5	.070in	1.034in	No	10-32	7512-000162	EJK-PACKTIP-1032-1034-070
5	.093in	1.034in	No	10-32	7512-000161	EJK-PACKTIP-1032-1034-093
5	.093in	1.034in	Yes	10-32	7512-000164	EJK-PACKTIP-1032-1034-093-IC
5	.120in	1.034in	Yes	10-32	7512-000160	EJK-PACKTIP-1032-1034-120-IC
5	.150in	1.034in	Yes	10-32	7512-000159	EJK-PACKTIP-1032-1034-150-IC
5	.200in	1.034in	Yes	10-32	7512-000158	EJK-PACKTIP-1032-1034-200-IC
5	.250in	1.034in	Yes	10-32	7512-000157	EJK-PACKTIP-1032-1034-250-IC
5	.310in	1.034in	Yes	10-32	7512-000155	EJK-PACKTIP-1032-1034-310-IC
5	.375in	1.034in	No	10-32	7512-000167	EJK-PACKTIP-1032-1034-375
5	.375in	1.034in	Yes	10-32	7512-000168	EJK-PACKTIP-1032-1034-375-IC
5	.437in	1.034in	No	10-32	7512-000165	EJK-PACKTIP-1032-1034-437
5	.437in	1.034in	Yes	10-32	7512-000166	EJK-PACKTIP-1032-1034-437-IC
5	.500in	1.034in	Yes	10-32	7512-000169	EJK-PACKTIP-1032-500-500-IC
5	.625in	1.034in	Yes	10-32	7512-000170	EJK-PACKTIP-1032-500-625-IC

## Assorted Tip Kits

Machine(s)	Pieces	Diameter	Length	Coolant-Thru	Thread	Item No.	Kit No.
CITIZEN 12mm	4	.040in	.850in	No	4-48	7512-000135	EJK-0448-KIT-A*
		.060in	.850in	No	4-48		
		.090in	.850in	No	4-48		
		.120in	.850in	No	4-48		
CITIZEN 12, 16, 20, 25, 32mm	9	.040in	1.034in	No	10-32	7512-000134	EJK-1032-KIT-A
		.070in	1.034in	No	10-32		
		.093in	1.034in	No	10-32		
		.093in	1.034in	Yes	10-32		
		.120in	1.034in	Yes	10-32		
		.150in	1.034in	Yes	10-32		
		.200in	1.034in	Yes	10-32		
		.250in	1.034in	Yes	10-32		
STAR 16, 20, 25, & 32mm  TSUGAMI 16 & 20mm	13	.040in	1.034in	No	10-32	7512-000142	EJK-STTS1032-KIT-A
		.070in	1.034in	No	10-32		
		.093in	1.034in	No	10-32		
		.375in	1.034in	No	10-32		
		.437in	1.034in	No	10-32		
		.093in	1.034in	Yes	10-32		
		.120in	1.034in	Yes	10-32		
		.150in	1.034in	Yes	10-32		
		.200in	1.034in	Yes	10-32		
		.250in	1.034in	Yes	10-32		
		.310in	1.034in	Yes	10-32		
		.375in	1.034in	Yes	10-32		
		.437in	1.034in	Yes	10-32		

\*Requires a base from kit EJK-CIT12-KIT-A or base kit EJK-PACKBASE-M5-448-155-IC for 12mm Citizen machines