



multidec® - MICRO TOOLS

**Drilling & Milling Solutions
for Micro-Machining**



UTILIS
multidec®
swiss type tools

UTILIS
u-drill

UTILIS
u-mill

UTILIS
u-hexalob

multidec[®]-MICRO TOOLS

Introducing the new multidec[®]-MICRO TOOLS from UTILIS offering a range of solid carbide micro-tools for drilling, milling and Torx milling. The range is divided into three sections: u-drill includes spot drills and twist drills, u-mill includes end mills and ball nose end mills and u-hexalob includes micro tools for milling the TORX[®] contour in titanium and stainless steel screws. The multidec[®]-MICRO TOOLS range is continually being expanded and extended.

U-DRILL

Solid carbide spot drills and twist drills

Overview:

- 90° and 120° NC spot drills from Ø 1 to 6 mm
- Solid carbide twist drills from Ø 0.3 to 1 mm in 0.05 mm steps available from Ø 1 in 0.1 mm steps up to Ø 3 mm available, in 3×d₁ length with reinforced shank, self-centering shape
- Solid carbide twist drill from Ø 0.1 to 0.29 mm in 0.01 mm steps available 7×d₁ version with reinforced shank, self-centering shape
- Solid carbide twist drill from Ø 0.3 to 2.00 mm in 0.01 mm steps available from Ø 2.05 to 3.00 mm in 0.05 mm steps available, 5–8×d₁ length version with reinforced shank, self-centering shape



U-MILL

Solid carbide end mills and ball nose end mills

Overview:

- Solid carbide end mills from Ø 0.2 to 3.00 mm with center cut, as 2 and 3 teeth
- Solid carbide ball nose end mills from Ø 0.3 to 3.00 mm, 0.75×d₁ and 3×d₁ length with center cut and without tooth pitch

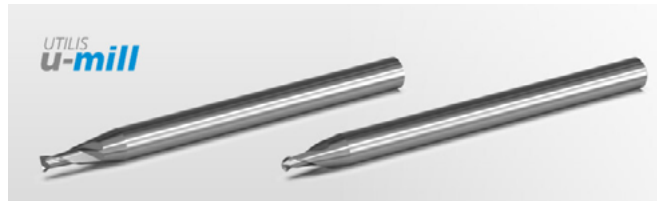

U-HEXALOBE

Solid carbide micro tools for milling TORX[®] contours, optimized geometry for machining stainless steel and titanium.

Overview:

- Solid carbide pilot drills from Ø 0.90 to 3.90 mm for spotting and centering with a 120° chamfer
- Solid carbide end mills with three teeth, from Ø 0.20 to 0.30 mm, usable length of 3.5×d₁ and 5×d₁, perfectly suited for milling a TORX[®] form
- Solid carbide end mills with four teeth, from Ø 0.40 to 1.00 mm, usable length of 3.5×d₁ and 5×d₁, perfectly suited for milling a TORX[®] form



multidec®-MICRO TOOLS

All dimensions are in millimeter (mm); native dimensions in inch are calculated into millimeter.

u-drill micro drills series descriptions

Solid Carbide micro tools, spot drills and twist drills

Application	Series	D1 Flute Ø	L1 Length of Cut	L2 Neck Length	Drill Point	Helix	Tolerance
Spot Drills	UMCD ... PT120°	1.00–6.00	2.5-15.0	-	-	20°	h6
Spot Drills	UMCD ... PT90°	1.00–6.00	2.5-15.0	-	-	20°	h6
Spot Drills	UMCDS ... PT90°	3.00–6.00	3.0-6.0	-	-	-	h6
Twist Drills	UMDSX ...	0.30–3.00	0.9-9.0	1.4-12.2	1.4-12.2	35°	h6
Twist Drills	UMDLF ...	0.10–0.29	0.7-2.05	0.95-2.55	0.95-2.55	30°	h6
Twist Drills	UMDLX ...	0.30–3.00	1.5-18.0	1.8-20.0	1.8-20.0	35°	h6
Twist Drills	UMDS ...	0.10–3.00	0.25-4.5	0.4-5.8	0.4-5.8	24°	h6
Twist Drills	UMDL ...	0.10–3.00	0.6-12.00	0.8-14.0	0.8-14.0	24°	h6

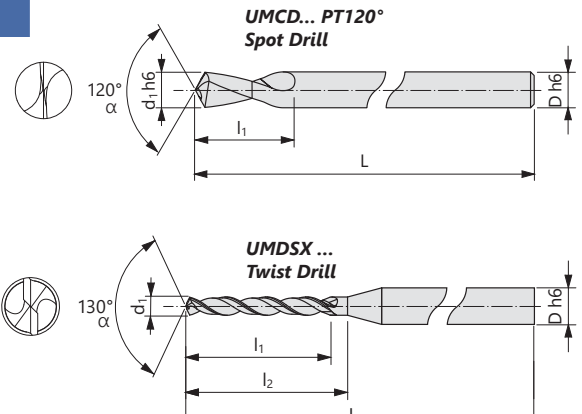

u-mill micro mills series descriptions

Solid Carbide micro tools, end mills and ball nose end mills

Application	Series	D1 Flute Ø	L1 Length of Cut	# of Flutes	Helix	Tolerance	Full Radius
End Mills	UMM 2... x 02	0.20–3.00	0.4-6.0	2	30°	h5	-
End Mills	UMM 2... x 035	0.20–3.00	0.7-10.5	2	30°	h5	-
End Mills	UMM 2... x 05	0.30–3.00	1.5-15.0	2	30°	h5	-
End Mills	UMM 3... x 02	0.30–3.00	0.6-6.0	3	30°	h5	-
End Mills	UMM 3... x 035	0.30–3.00	1.1-10.5	3	30°	h5	-
End Mills	UMM 3... x 05	0.30–3.00	1.5-15.0	3	30°	h5	-
Ball Nose	UMMB 2... x 0075	0.30–3.00	0.23-2.25	2	30°	h5	Yes
Ball Nose	UMMB 2... x 03	0.30–3.00	0.9-9.0	2	30°	h5	Yes

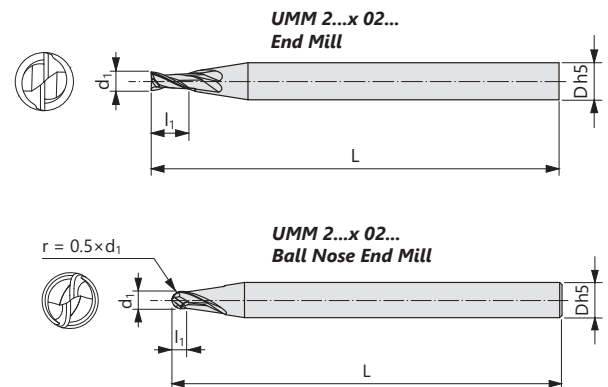

u-hexalob micro drills and micro mills series descriptions

Solid Carbide micro tools for milling TORX® contours

Application	Series	D1 Flute Ø	L2 Neck Length	# of Flutes	Drill Point	Helix	Tolerance
Pilot Mills	UMDT ...	0.90–3.90	2.7-12.6		140°	~25°	h6
End Mills	UMMT ... x 018 H035 ...	0.20–0.30	0.7-3.5	3		30°	h5
End Mills	UMMT ... x 018 H035 ...	0.40–1.00	0.7-3.5	4		30°	h5
End Mills	UMMT ... x 018 H05 ...	0.20–0.30	1.0-5.0	3		30°	h5
End Mills	UMMT ... x 018 H05 ...	0.40–1.00	1.0-5.0	4		30°	h5

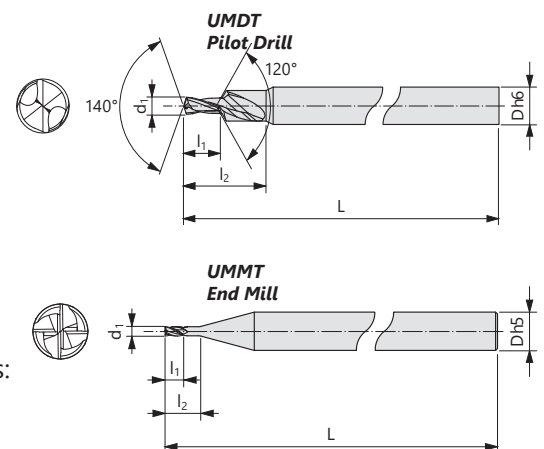

The dimensions listed in the tool tables refer to the following tool parameters:

D	Shank Diameter
d ₁	Flute Diameter
d ₂	Flank Diameter
l ₁	Flute Length/Length of Cut
l ₂	Neck Length
L	Overall Length
α	Drill Point Angle
Z	Number of flutes (teeth)

Symbols for tool attributes



Number of cutting edges
Example: Two cutting edges

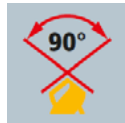

Point angle
Example: Point angle 90°



Cutting edge preparation
Example: Sharp



Helix angle
Example: Helix angle 20°

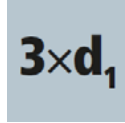

Cutting length
Example: Drilling depth $3 \times d_1$



Example: Full Radius



Machining direction
Example: Machining in all directions possible

UMCD ... PT120°							
UMCD ... PT90°							
UMCDS ... PT90°							
UMDSX ...						$3 \times d_1$	
UMDLF ...						$7 \times d_1$	
UMDLX ...						$6-8 \times d_1$ <small>< Ø0.45 4-5 $\times d_1$</small>	
UMDS...						$2-3 \times d_1$	
UMDL						$5-8 \times d_1$	
UMM2... x 02						$2 \times d_1$	
UMM2... x 035						$3.5 \times d_1$	

Symbols for tool attributes



Number of cutting edges
Example: Two cutting edges

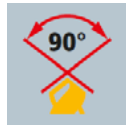

Point angle
Example: Point angle 90°



Cutting edge preparation
Example: Sharp



Helix angle
Example: Helix angle 20°

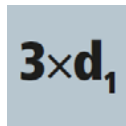

Cutting length
Example: Drilling depth $3d_1$



Example: Full Radius



Machining direction
Example: Machining in all directions possible

UMM2... x 05						$5 \times d_1$	
UMM3... x 02						$2 \times d_1$	
UMM 3... x 035						$3.5 \times d_1$	
UMM 3... x 05						$5 \times d_1$	
UMMB 2... x 0075						$0.75 \times d_1$	
UMMB 2... x 03						$3 \times d_1$	
UMDT ...							
UMMT... x 018 H035 ...	 $d_1 \leq 0.30$	 $d_1 \leq 0.40$				$l_2 = 3.5 \times d_1$	
UMMT... x 018 H05 ...	 $d_1 \leq 0.30$	 $d_1 \leq 0.40$				$l_2 = 5 \times d_1$	

multidec®-MICRO TOOLS

UTILIS
u-drill

	UMCD PT120° 120°	Spot Drills	Pg. 11
	UMCD PT90° 90°	Spot Drills	Pg. 11
	UMCDS PT90° 90°	Spot Drills	Pg. 11
	UMDSX 130° 03XD	Twist Drills	Pg. 12-13
	UMDLF 120° 07XD In 0.01 mm steps up to Ø 2.00 mm	Twist Drills	Pg. 13-14
	UMDLX 130° 08XD 07XD 06XD In 0.01 mm steps up to Ø 2.00 mm	Twist Drills	Pg. 14-22
	UMDS 118° 03XD 02XD	Twist Drills	Pg. 22-23
	UMDL 118° 08XD 07XD 06XD 05XD	Twist Drills	Pg. 24-25
	UMDT 140° 140°	Pilot Drills	Pg. 31

Micro drills cutting specification

Materials (category) Hardness value (HB) / (HRC)	Uncoated HMB		Coated HMB		
	<i>Cutting speeds Vc (m/min)</i>	<i>Surface Foot per min (SFM) inches</i>	<i>Cutting speeds Vc (m/min)</i>	<i>Surface Foot per min (SFM) inches</i>	<i>Feeds f (mm/rev)</i>
Steel non-alloyed (I) 125–300 HB	30–70	114-266	35–75	133-285	d ₁ /80
Steel low alloyed (II) 180–250 HB	25–60	95-228	30–65	114-247	d ₁ /80
Steel high alloyed (III) 200–350 HB	20–45	76-171	25–55	95-209	d ₁ /80
Stainless steel (V) 180–220 HB	20–40	76-152	25–50	95-190	d ₁ /80
Stainless steel (VI) 220–330 HB	15–35	57-133	20–40	76-152	d ₁ /80
Titanium (IV)	15–35	57-133	20–40	76-152	d ₁ /100
Aluminum (VII) 60–130 HB	50–120	190-456	60–140	228-532	d ₁ /60
Brass / lead-free brass (VIII)	40–90	152-342	45–100	171-380	d ₁ /80
Copper / Bronze (VIII)	35–75	133-285	40–80	152-304	d ₁ /80
Precious metals (VIII)	30–70	114-266	35–80	133-304	d ₁ /80
Hard materials (X) 45–55 HRC	–	–	12–25	45.6-95	d ₁ /120

Remarks

Lower cutting speeds are possible when using very small diameter tools (for example Ø 0.30 mm by 6000 RPM = 5.7 m/min)
Feed rate is a medium value for a first setup. Higher speeds are possible for ideal machining conditions.
Please contact our application engineers **call 413-562-4800** or **email sales@genswiss.com** for more information.

multidec[®]-MICRO TOOLS

	UMM 2... x 02 All Materials	End Mills	Pg. 25-26
	UMM 2... x 035 All Materials	End Mills	Pg. 26
	UMM 2... x 05 All Materials	End Mills	Pg. 27
	UMM 3... x 02 All Materials	End Mills	Pg. 27-28
	UMM 3... x 035 All Materials	End Mills	Pg. 28
	UMM 3... x 05 All Materials	End Mills	Pg. 29
	UMMB 2... x 0075 All Materials	Ball Nose End Mills	Pg. 29-30
	UMMB 2... x 03 All Materials	Ball Nose End Mills	Pg. 30-31
	UMMT ... x 018 H035 All Materials	End Mills	Pg. 32
	UMMT ... x 018 H05 All Materials	End Mills	Pg. 32

UTILIS
u-mill

UTILIS
u-hexalob

Micro mills cutting specification

Materials (category) Hardness value (HB) / (HRC)	Uncoated HMB		Coated HMB		
	<i>Cutting speeds Vc (m/min)</i>	<i>Surface Foot per min (SFM) inches</i>	<i>Cutting speeds Vc (m/min)</i>	<i>Surface Foot per min (SFM) inches</i>	<i>Feeds fz (mm/Z)</i>
Steel non-alloyed (I) 125–300 HB	60–80	228-304	70–100	266-380	d ₁ /150
Steel low alloyed (II) 180–250 HB	50–70	190-266	60–90	228-342	d ₁ /150
Steel high alloyed (III) 200–350 HB	40–60	152-228	50–80	190-304	d ₁ /150
Stainless steel (V) 180–220 HB	35–70	133-266	40–80	152-304	d ₁ /150
Stainless steel (VI) 220–330 HB	30–60	114-228	35–70	133-266	d ₁ /150
Titanium (IV)	20–45	76-171	25–50	95-190	d ₁ /180
Aluminum (VII) 60–130 HB	100–250	380-950	120–300	456-1,140	d ₁ /100
Brass / lead-free brass (VIII)	80–200	304-760	100–250	380-950	d ₁ /150
Copper / Bronze (VIII)	60–140	228-532	80–160	304-608	d ₁ /150
Precious metals (VIII)	80–140	304-532	100–160	380-608	d ₁ /150
Hard materials (X) 45–55 HRC	–		25–60	95-228	d ₁ /200

Remarks

Lower cutting speeds are possible when using very small diameter tools (for example Ø 0.30 mm by 6000 RPM = 5.7 m/min)
 Feed rate is a medium value for a first setup. Higher speeds are possible for ideal machining conditions.
 Please contact our application engineers **call 413-562-4800** or **email sales@genwiss.com** for more information.

multidec®-MICRO TOOLS

NOTE: all dimensions are in millimeter (mm)

UTILIS
u-drill

DESIGNATION SYSTEM FOR DRILLS

UMDLX 0100 S30 HMP 700

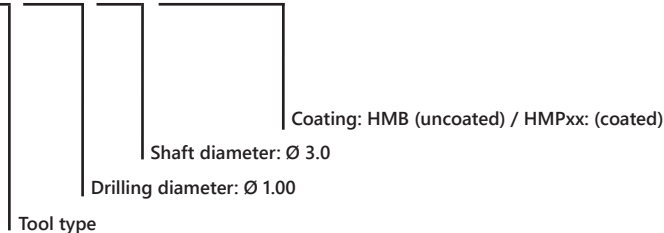

DESIGNATION SYSTEM FOR MILLS

UTILIS
u-mill

UMM 20030 x 035 S30 HMB

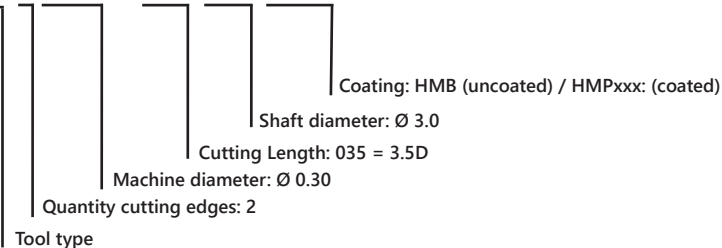

DESIGNATION SYSTEM FOR TORX® - FORM DRILLS

UTILIS
u-hexalob

UMDT 4-0090 x 071 S30 HMP700

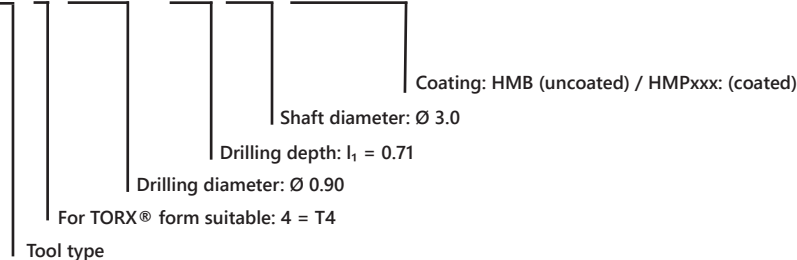

DESIGNATION SYSTEM FOR TORX® - FORM END MILLS

UTILIS
u-hexalob

UMMT 40100 x 018 H035 S40 HMP600

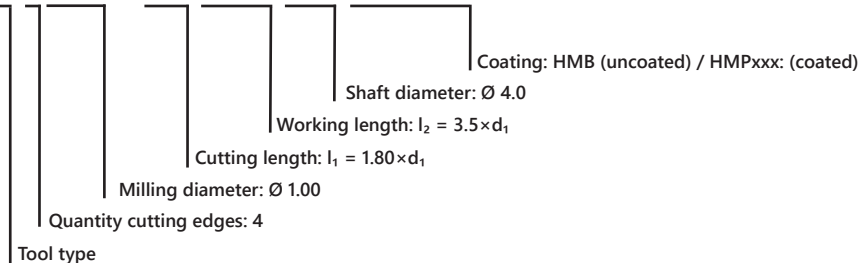

Spot Drills - Solid Carbide
Thinned drill-tip for precise centering

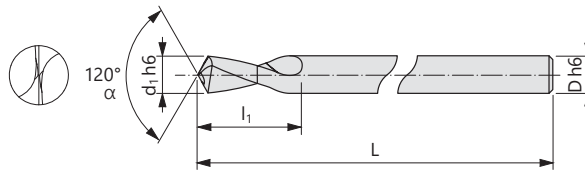

Symbols Key (Pages 4 & 5)

UMCD... PT120°

Item No.	Description	d1 h6 Flute Ø	α Drill Point Angle	l ₁ Flute Length	D h6 Shank Ø	L OAL	Coating
7006-270259	UMCD 0100 S10 PT120° HMB	1.00mm	120°	2.50mm	1.00mm	30mm	Uncoated
7006-270260	UMCD 0100 S10 PT120° HMP600	1.00mm	120°	2.50mm	1.00mm	30mm	HMP600
7006-270261	UMCD 0150 S15 PT120° HMB	1.50mm	120°	3.80mm	1.50mm	30mm	Uncoated
7006-270262	UMCD 0150 S15 PT120° HMP600	1.50mm	120°	3.80mm	1.50mm	30mm	HMP600
7006-270263	UMCD 0200 S20 PT120° HMB	2.00mm	120°	5.00mm	2.00mm	38mm	Uncoated
7006-270264	UMCD 0200 S20 PT120° HMP600	2.00mm	120°	5.00mm	2.00mm	38mm	HMP600
7006-270265	UMCD 0250 S25 PT120° HMB	2.50mm	120°	6.30mm	2.50mm	38mm	Uncoated
7006-270266	UMCD 0250 S25 PT120° HMP600	2.50mm	120°	6.30mm	2.50mm	38mm	HMP600
7006-270267	UMCD 0300 S30 PT120° HMB	3.00mm	120°	7.50mm	3.00mm	38mm	Uncoated
7006-270268	UMCD 0300 S30 PT120° HMP600	3.00mm	120°	7.50mm	3.00mm	38mm	HMP600
7006-270269	UMCD 0400 S40 PT120° HMB	4.00mm	120°	10.00mm	4.00mm	45mm	Uncoated
7006-270270	UMCD 0400 S40 PT120° HMP600	4.00mm	120°	10.00mm	4.00mm	45mm	HMP600
7006-270271	UMCD 0500 S50 PT120° HMB	5.00mm	120°	12.50mm	5.00mm	50mm	Uncoated
7006-270272	UMCD 0500 S50 PT120° HMP600	5.00mm	120°	12.50mm	5.00mm	50mm	HMP600
7006-270273	UMCD 0600 S60 PT120° HMB	6.00mm	120°	15.00mm	6.00mm	60mm	Uncoated
7006-270274	UMCD 0600 S60 PT120° HMP600	6.00mm	120°	15.00mm	6.00mm	60mm	HMP600

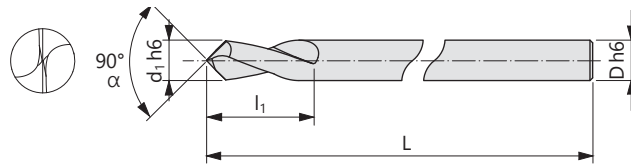

Symbols Key (Pages 4 & 5)

UMCD... PT90°

Item No.	Description	d1 h6 Flute Ø	α Drill Point Angle	l ₁ Flute Length	D h6 Shank Ø	L OAL	Coating
7006-270243	UMCD 0100 S10 PT90° HMB	1.00mm	90°	2.50mm	1.00mm	30mm	Uncoated
7006-270244	UMCD 0100 S10 PT90° HMP600	1.00mm	90°	2.50mm	1.00mm	30mm	HMP600
7006-270245	UMCD 0150 S15 PT90° HMB	1.50mm	90°	3.80mm	1.50mm	30mm	Uncoated
7006-270246	UMCD 0150 S15 PT90° HMP600	1.50mm	90°	3.80mm	1.50mm	30mm	HMP600
7006-270247	UMCD 0200 S20 PT90° HMB	2.00mm	90°	5.00mm	2.00mm	38mm	Uncoated
7006-270248	UMCD 0200 S20 PT90° HMP600	2.00mm	90°	5.00mm	2.00mm	38mm	HMP600
7006-270249	UMCD 0250 S25 PT90° HMB	2.50mm	90°	6.30mm	2.50mm	38mm	Uncoated
7006-270250	UMCD 0250 S25 PT90° HMP600	2.50mm	90°	6.30mm	2.50mm	38mm	HMP600
7006-270251	UMCD 0300 S30 PT90° HMB	3.00mm	90°	7.50mm	3.00mm	38mm	Uncoated
7006-270252	UMCD 0300 S30 PT90° HMP600	3.00mm	90°	7.50mm	3.00mm	38mm	HMP600
7006-270253	UMCD 0400 S40 PT90° HMB	4.00mm	90°	10.00mm	4.00mm	45mm	Uncoated
7006-270254	UMCD 0400 S40 PT90° HMP600	4.00mm	90°	10.00mm	4.00mm	45mm	HMP600
7006-270255	UMCD 0500 S50 PT90° HMB	5.00mm	90°	12.50mm	5.00mm	50mm	Uncoated
7006-270256	UMCD 0500 S50 PT90° HMP600	5.00mm	90°	12.50mm	5.00mm	50mm	HMP600
7006-270257	UMCD 0600 S60 PT90° HMB	6.00mm	90°	15.00mm	6.00mm	60mm	Uncoated
7006-270258	UMCD 0600 S60 PT90° HMP600	6.00mm	90°	15.00mm	6.00mm	60mm	HMP600

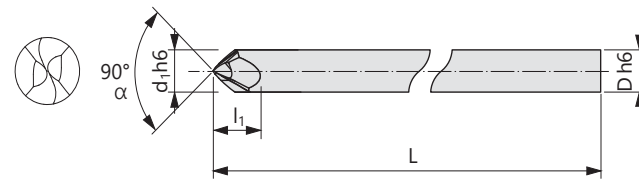

Symbols Key (Pages 4 & 5)

UMCDS... PT90°

Item No.	Description	d1 h6 Flute Ø	α Drill Point Angle	l ₁ Flute Length	D h6 Shank Ø	L OAL	Coating
7006-270237	UMCDS 0300 S30 PT90° HMB	3.00mm	90°	3.00mm	3.00mm	38mm	Uncoated
7006-270238	UMCDS 0300 S30 PT90° HMP700	3.00mm	90°	3.00mm	3.00mm	38mm	HMP700
7006-270239	UMCDS 0400 S40 PT90° HMB	4.00mm	90°	4.00mm	4.00mm	38mm	Uncoated
7006-270240	UMCDS 0400 S40 PT90° HMP700	4.00mm	90°	4.00mm	4.00mm	38mm	HMP700
7006-270241	UMCDS 0600 S60 PT90° HMB	6.00mm	90°	6.00mm	6.00mm	45mm	Uncoated
7006-270242	UMCDS 0600 S60 PT90° HMP700	6.00mm	90°	6.00mm	6.00mm	45mm	HMP700

Twist Drills - Solid Carbide with Reinforced Shank

With x-point for self-centering

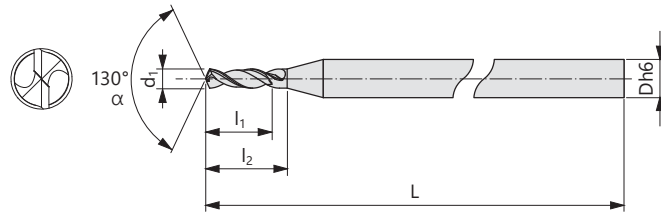

Symbols Key (Pages 4 & 5)

UMDSX ...

Item No.	Description	d1 Flute Ø	α Drill Point Angle	l ₁ Flute Length	l ₂ Neck Length	D h6 Shank Ø	L OAL	Coating
7006-270815	UMDSX 0030 S30 HMB	0.30mm	130°	0.90mm	1.40mm	3.00mm	38mm	Uncoated
7006-270816	UMDSX 0030 S30 HMP700	0.30mm	130°	0.90mm	1.40mm	3.00mm	38mm	HMP700
7006-270817	UMDSX 0035 S30 HMB	0.35mm	130°	1.10mm	1.60mm	3.00mm	38mm	Uncoated
7006-270818	UMDSX 0035 S30 HMP700	0.35mm	130°	1.10mm	1.60mm	3.00mm	38mm	HMP700
7006-270819	UMDSX 0040 S30 HMB	0.40mm	130°	1.20mm	1.80mm	3.00mm	38mm	Uncoated
7006-270820	UMDSX 0040 S30 HMP700	0.40mm	130°	1.20mm	1.80mm	3.00mm	38mm	HMP700
7006-270821	UMDSX 0045 S30 HMB	0.45mm	130°	1.40mm	2.00mm	3.00mm	38mm	Uncoated
7006-270822	UMDSX 0045 S30 HMP700	0.45mm	130°	1.40mm	2.00mm	3.00mm	38mm	HMP700
7006-270823	UMDSX 0050 S30 HMB	0.50mm	130°	1.50mm	2.20mm	3.00mm	38mm	Uncoated
7006-270824	UMDSX 0050 S30 HMP700	0.50mm	130°	1.50mm	2.20mm	3.00mm	38mm	HMP700
7006-270825	UMDSX 0055 S30 HMB	0.55mm	130°	1.70mm	2.40mm	3.00mm	38mm	Uncoated
7006-270826	UMDSX 0055 S30 HMP700	0.55mm	130°	1.70mm	2.40mm	3.00mm	38mm	HMP700
7006-270827	UMDSX 0060 S30 HMB	0.60mm	130°	1.80mm	2.60mm	3.00mm	38mm	Uncoated
7006-270828	UMDSX 0060 S30 HMP700	0.60mm	130°	1.80mm	2.60mm	3.00mm	38mm	HMP700
7006-270829	UMDSX 0065 S30 HMB	0.65mm	130°	2.00mm	2.70mm	3.00mm	38mm	Uncoated
7006-270830	UMDSX 0065 S30 HMP700	0.65mm	130°	2.00mm	2.70mm	3.00mm	38mm	HMP700
7006-270831	UMDSX 0070 S30 HMB	0.70mm	130°	2.10mm	3.00mm	3.00mm	38mm	Uncoated
7006-270832	UMDSX 0070 S30 HMP700	0.70mm	130°	2.10mm	3.00mm	3.00mm	38mm	HMP700
7006-270833	UMDSX 0075 S30 HMB	0.75mm	130°	2.30mm	3.20mm	3.00mm	38mm	Uncoated
7006-270834	UMDSX 0075 S30 HMP700	0.75mm	130°	2.30mm	3.20mm	3.00mm	38mm	HMP700
7006-270835	UMDSX 0080 S30 HMB	0.80mm	130°	2.40mm	3.40mm	3.00mm	38mm	Uncoated
7006-270836	UMDSX 0080 S30 HMP700	0.80mm	130°	2.40mm	3.40mm	3.00mm	38mm	HMP700
7006-270837	UMDSX 0085 S30 HMB	0.85mm	130°	2.60mm	3.50mm	3.00mm	38mm	Uncoated
7006-270838	UMDSX 0085 S30 HMP700	0.85mm	130°	2.60mm	3.50mm	3.00mm	38mm	HMP700
7006-270839	UMDSX 0090 S30 HMB	0.90mm	130°	2.70mm	3.70mm	3.00mm	38mm	Uncoated
7006-270840	UMDSX 0090 S30 HMP700	0.90mm	130°	2.70mm	3.70mm	3.00mm	38mm	HMP700
7006-270841	UMDSX 0095 S30 HMB	0.95mm	130°	2.90mm	3.90mm	3.00mm	38mm	Uncoated
7006-270842	UMDSX 0095 S30 HMP700	0.95mm	130°	2.90mm	3.90mm	3.00mm	38mm	HMP700
7006-270843	UMDSX 0100 S30 HMB	1.00mm	130°	3.00mm	4.20mm	3.00mm	38mm	Uncoated
7006-270844	UMDSX 0100 S30 HMP700	1.00mm	130°	3.00mm	4.20mm	3.00mm	38mm	HMP700
7006-270845	UMDSX 0110 S30 HMB	1.10mm	130°	3.30mm	4.60mm	3.00mm	38mm	Uncoated
7006-270846	UMDSX 0110 S30 HMP700	1.10mm	130°	3.30mm	4.60mm	3.00mm	38mm	HMP700
7006-270847	UMDSX 0120 S30 HMB	1.20mm	130°	3.60mm	4.90mm	3.00mm	38mm	Uncoated
7006-270848	UMDSX 0120 S30 HMP700	1.20mm	130°	3.60mm	4.90mm	3.00mm	38mm	HMP700
7006-270849	UMDSX 0130 S30 HMB	1.30mm	130°	3.90mm	5.30mm	3.00mm	38mm	Uncoated
7006-270850	UMDSX 0130 S30 HMP700	1.30mm	130°	3.90mm	5.30mm	3.00mm	38mm	HMP700
7006-270851	UMDSX 0140 S30 HMB	1.40mm	130°	4.20mm	5.80mm	3.00mm	38mm	Uncoated
7006-270852	UMDSX 0140 S30 HMP700	1.40mm	130°	4.20mm	5.80mm	3.00mm	38mm	HMP700
7006-270853	UMDSX 0150 S30 HMB	1.50mm	130°	4.50mm	6.20mm	3.00mm	38mm	Uncoated
7006-270854	UMDSX 0150 S30 HMP700	1.50mm	130°	4.50mm	6.20mm	3.00mm	38mm	HMP700
7006-270855	UMDSX 0160 S30 HMB	1.60mm	130°	4.80mm	6.60mm	3.00mm	38mm	Uncoated
7006-270856	UMDSX 0160 S30 HMP700	1.60mm	130°	4.80mm	6.60mm	3.00mm	38mm	HMP700
7006-270857	UMDSX 0170 S30 HMB	1.70mm	130°	5.10mm	7.00mm	3.00mm	38mm	Uncoated
7006-270858	UMDSX 0170 S30 HMP700	1.70mm	130°	5.10mm	7.00mm	3.00mm	38mm	HMP700
7006-270859	UMDSX 0180 S30 HMB	1.80mm	130°	5.40mm	7.30mm	3.00mm	38mm	Uncoated
7006-270860	UMDSX 0180 S30 HMP700	1.80mm	130°	5.40mm	7.30mm	3.00mm	38mm	HMP700
7006-270861	UMDSX 0190 S30 HMB	1.90mm	130°	5.70mm	7.70mm	3.00mm	38mm	Uncoated
7006-270862	UMDSX 0190 S30 HMP700	1.90mm	130°	5.70mm	7.70mm	3.00mm	38mm	HMP700
7006-270863	UMDSX 0200 S30 HMB	2.00mm	130°	6.00mm	8.20mm	3.00mm	38mm	Uncoated
7006-270864	UMDSX 0200 S30 HMP700	2.00mm	130°	6.00mm	8.20mm	3.00mm	38mm	HMP700
7006-270865	UMDSX 0210 S30 HMB	2.10mm	130°	6.30mm	8.60mm	3.00mm	45mm	Uncoated
7006-270866	UMDSX 0210 S30 HMP700	2.10mm	130°	6.30mm	8.60mm	3.00mm	45mm	HMP700

Twist Drills - Solid Carbide with Reinforced Shank

With x-point for self-centering

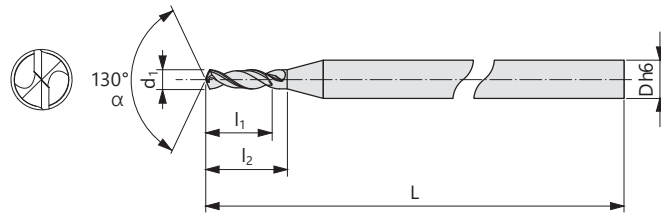

UTILIS
u-drill



Symbols Key (Pages 4 & 5)

UMDSX ...

Item No.	Description	d1 Flute Ø	α Drill Point Angle	l ₁ Flute Length	l ₂ Neck Length	D h6 Shank Ø	L OAL	Coating
7006-270867	UMDSX 0220 S30 HMB	2.20mm	130°	6.60mm	8.90mm	3.00mm	45mm	Uncoated
7006-270868	UMDSX 0220 S30 HMP700	2.20mm	130°	6.60mm	8.90mm	3.00mm	45mm	HMP700
7006-270869	UMDSX 0230 S30 HMB	2.30mm	130°	6.90mm	9.40mm	3.00mm	45mm	Uncoated
7006-270870	UMDSX 0230 S30 HMP700	2.30mm	130°	6.90mm	9.40mm	3.00mm	45mm	HMP700
7006-270871	UMDSX 0240 S30 HMB	2.40mm	130°	7.20mm	9.80mm	3.00mm	45mm	Uncoated
7006-270872	UMDSX 0240 S30 HMP700	2.40mm	130°	7.20mm	9.80mm	3.00mm	45mm	HMP700
7006-270873	UMDSX 0250 S30 HMB	2.50mm	130°	7.50mm	10.20mm	3.00mm	45mm	Uncoated
7006-270874	UMDSX 0250 S30 HMP700	2.50mm	130°	7.50mm	10.20mm	3.00mm	45mm	HMP700
7006-270875	UMDSX 0260 S30 HMB	2.60mm	130°	7.80mm	10.60mm	3.00mm	45mm	Uncoated
7006-270876	UMDSX 0260 S30 HMP700	2.60mm	130°	7.80mm	10.60mm	3.00mm	45mm	HMP700
7006-270877	UMDSX 0270 S30 HMB	2.70mm	130°	8.10mm	10.90mm	3.00mm	45mm	Uncoated
7006-270878	UMDSX 0270 S30 HMP700	2.70mm	130°	8.10mm	10.90mm	3.00mm	45mm	HMP700
7006-270879	UMDSX 0280 S30 HMB	2.80mm	130°	8.40mm	11.40mm	3.00mm	45mm	Uncoated
7006-270880	UMDSX 0280 S30 HMP700	2.80mm	130°	8.40mm	11.40mm	3.00mm	45mm	HMP700
7006-270881	UMDSX 0290 S30 HMB	2.90mm	130°	8.70mm	11.70mm	3.00mm	45mm	Uncoated
7006-270882	UMDSX 0290 S30 HMP700	2.90mm	130°	8.70mm	11.70mm	3.00mm	45mm	HMP700
7006-270883	UMDSX 0300 S30 HMB	3.00mm	130°	9.00mm	12.20mm	3.00mm	45mm	Uncoated
7006-270884	UMDSX 0300 S30 HMP700	3.00mm	130°	9.00mm	12.20mm	3.00mm	45mm	HMP700

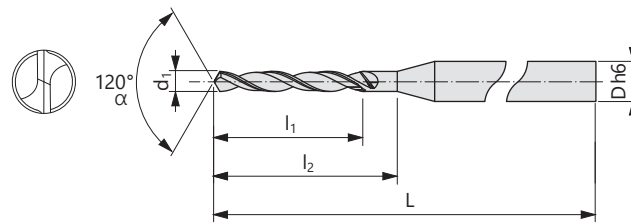

Symbols Key (Pages 4 & 5)

UMDLF ...

Point relief: 4 facet, 120°

Item No.	Description	d1 Flute Ø	α Drill Point Angle	l ₁ Flute Length	l ₂ Neck Length	D h6 Shank Ø	L OAL	Coating
7006-270275	UMDLF 0010 S30 HMB	0.10mm	120°	0.70mm	0.95mm	3.0mm	38mm	Uncoated
7006-270276	UMDLF 0010 S30 HMP700	0.10mm	120°	0.70mm	0.95mm	3.0mm	38mm	HMP700
7006-270277	UMDLF 0011 S30 HMB	0.11mm	120°	0.75mm	1.00mm	3.0mm	38mm	Uncoated
7006-270278	UMDLF 0011 S30 HMP700	0.11mm	120°	0.75mm	1.00mm	3.0mm	38mm	HMP700
7006-270279	UMDLF 0012 S30 HMB	0.12mm	120°	0.85mm	1.10mm	3.0mm	38mm	Uncoated
7006-270280	UMDLF 0012 S30 HMP700	0.12mm	120°	0.85mm	1.10mm	3.0mm	38mm	HMP700
7006-270281	UMDLF 0013 S30 HMB	0.13mm	120°	0.90mm	1.15mm	3.0mm	38mm	Uncoated
7006-270282	UMDLF 0013 S30 HMP700	0.13mm	120°	0.90mm	1.15mm	3.0mm	38mm	HMP700
7006-270283	UMDLF 0014 S30 HMB	0.14mm	120°	1.00mm	1.25mm	3.0mm	38mm	Uncoated
7006-270284	UMDLF 0014 S30 HMP700	0.14mm	120°	1.00mm	1.25mm	3.0mm	38mm	HMP700
7006-270285	UMDLF 0015 S30 HMB	0.15mm	120°	1.05mm	1.35mm	3.0mm	38mm	Uncoated
7006-270286	UMDLF 0015 S30 HMP700	0.15mm	120°	1.05mm	1.35mm	3.0mm	38mm	HMP700
7006-270287	UMDLF 0016 S30 HMB	0.16mm	120°	1.10mm	1.50mm	3.0mm	38mm	Uncoated
7006-270288	UMDLF 0016 S30 HMP700	0.16mm	120°	1.10mm	1.50mm	3.0mm	38mm	HMP700
7006-270289	UMDLF 0017 S30 HMB	0.17mm	120°	1.20mm	1.60mm	3.0mm	38mm	Uncoated
7006-270290	UMDLF 0017 S30 HMP700	0.17mm	120°	1.20mm	1.60mm	3.0mm	38mm	HMP700
7006-270291	UMDLF 0018 S30 HMB	0.18mm	120°	1.25mm	1.65mm	3.0mm	38mm	Uncoated
7006-270292	UMDLF 0018 S30 HMP700	0.18mm	120°	1.25mm	1.65mm	3.0mm	38mm	HMP700
7006-270293	UMDLF 0019 S30 HMB	0.19mm	120°	1.35mm	1.75mm	3.0mm	38mm	Uncoated
7006-270294	UMDLF 0019 S30 HMP700	0.19mm	120°	1.35mm	1.75mm	3.0mm	38mm	HMP700
7006-270295	UMDLF 0020 S30 HMB	0.20mm	120°	1.40mm	1.85mm	3.0mm	38mm	Uncoated
7006-270296	UMDLF 0020 S30 HMP700	0.20mm	120°	1.40mm	1.85mm	3.0mm	38mm	HMP700

Twist Drills - Solid Carbide with Reinforced Shank

UTILIS
u-drill



UMDLF ...
Point relief: 4 facet, 120°

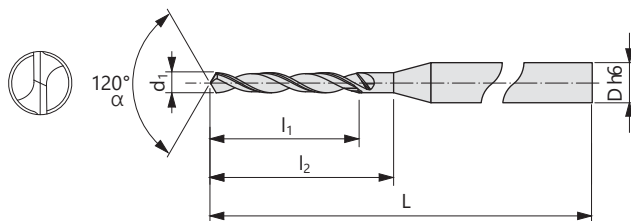

Symbols Key (Pages 4 & 5)

Item No.	Description	d1 Flute Ø	α Drill Point Angle	l1 Flute Length	l2 Neck Length	D h6 Shank Ø	L OAL	Coating
7006-270297	UMDLF 0021 S30 HMB	0.21mm	120°	1.45mm	1.90mm	3.00mm	38mm	Uncoated
7006-270298	UMDLF 0021 S30 HMP700	0.21mm	120°	1.45mm	1.90mm	3.00mm	38mm	HMP700
7006-270299	UMDLF 0022 S30 HMB	0.22mm	120°	1.55mm	2.00mm	3.00mm	38mm	Uncoated
7006-270300	UMDLF 0022 S30 HMP700	0.22mm	120°	1.55mm	2.00mm	3.00mm	38mm	HMP700
7006-270301	UMDLF 0023 S30 HMB	0.23mm	120°	1.60mm	2.00mm	3.00mm	38mm	Uncoated
7006-270302	UMDLF 0023 S30 HMP700	0.23mm	120°	1.60mm	2.00mm	3.00mm	38mm	HMP700
7006-270303	UMDLF 0024 S30 HMB	0.24mm	120°	1.70mm	2.15mm	3.00mm	38mm	Uncoated
7006-270304	UMDLF 0024 S30 HMP700	0.24mm	120°	1.70mm	2.15mm	3.00mm	38mm	HMP700
7006-270305	UMDLF 0025 S30 HMB	0.25mm	120°	1.75mm	2.25mm	3.00mm	38mm	Uncoated
7006-270306	UMDLF 0025 S30 HMP700	0.25mm	120°	1.75mm	2.25mm	3.00mm	38mm	HMP700
7006-270307	UMDLF 0026 S30 HMB	0.26mm	120°	1.80mm	2.30mm	3.00mm	38mm	Uncoated
7006-270308	UMDLF 0026 S30 HMP700	0.26mm	120°	1.80mm	2.30mm	3.00mm	38mm	HMP700
7006-270309	UMDLF 0027 S30 HMB	0.27mm	120°	1.90mm	2.40mm	3.00mm	38mm	Uncoated
7006-270310	UMDLF 0027 S30 HMP700	0.27mm	120°	1.90mm	2.40mm	3.00mm	38mm	HMP700
7006-270311	UMDLF 0028 S30 HMB	0.28mm	120°	1.95mm	2.50mm	3.00mm	38mm	Uncoated
7006-270312	UMDLF 0028 S30 HMP700	0.28mm	120°	1.95mm	2.50mm	3.00mm	38mm	HMP700
7006-270313	UMDLF 0029 S30 HMB	0.29mm	120°	2.05mm	2.55mm	3.00mm	38mm	Uncoated
7006-270314	UMDLF 0029 S30 HMP700	0.29mm	120°	2.05mm	2.55mm	3.00mm	38mm	HMP700



UMDLX ...
Point relief: 4 facet, 130° With x-point for self-centering

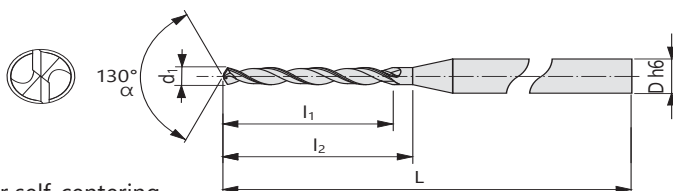

< Ø 0.45
4-5 x d1 Symbols Key (Pages 4 & 5)

Item No.	Description	d1 Flute Ø	α Drill Point Angle	l1 Flute Length	l2 Neck Length	D h6 Shank Ø	L OAL	Coating
7006-270433	UMDLX 0030 S30 HMB	0.30mm	130°	1.50mm	1.80mm	3.00mm	38mm	Uncoated
7006-270434	UMDLX 0030 S30 HMP700	0.30mm	130°	1.50mm	1.80mm	3.00mm	38mm	HMP700
7006-270435	UMDLX 0031 S30 HMB	0.31mm	130°	1.50mm	1.80mm	3.00mm	38mm	Uncoated
7006-270436	UMDLX 0031 S30 HMP700	0.31mm	130°	1.50mm	1.80mm	3.00mm	38mm	HMP700
7006-270437	UMDLX 0032 S30 HMB	0.32mm	130°	1.50mm	1.80mm	3.00mm	38mm	Uncoated
7006-270438	UMDLX 0032 S30 HMP700	0.32mm	130°	1.50mm	1.80mm	3.00mm	38mm	HMP700
7006-270439	UMDLX 0033 S30 HMB	0.33mm	130°	1.50mm	1.80mm	3.00mm	38mm	Uncoated
7006-270440	UMDLX 0033 S30 HMP700	0.33mm	130°	1.50mm	1.80mm	3.00mm	38mm	HMP700
7006-270441	UMDLX 0034 S30 HMB	0.34mm	130°	1.50mm	1.80mm	3.00mm	38mm	Uncoated
7006-270442	UMDLX 0034 S30 HMP700	0.34mm	130°	1.50mm	1.80mm	3.00mm	38mm	HMP700
7006-270443	UMDLX 0035 S30 HMB	0.35mm	130°	1.50mm	1.80mm	3.00mm	38mm	Uncoated
7006-270444	UMDLX 0035 S30 HMP700	0.35mm	130°	1.50mm	1.80mm	3.00mm	38mm	HMP700
7006-270445	UMDLX 0036 S30 HMB	0.36mm	130°	1.50mm	1.80mm	3.00mm	38mm	Uncoated
7006-270446	UMDLX 0036 S30 HMP700	0.36mm	130°	1.50mm	1.80mm	3.00mm	38mm	HMP700
7006-270447	UMDLX 0037 S30 HMB	0.37mm	130°	1.50mm	1.80mm	3.00mm	38mm	Uncoated
7006-270448	UMDLX 0037 S30 HMP700	0.37mm	130°	1.50mm	1.80mm	3.00mm	38mm	HMP700
7006-270449	UMDLX 0038 S30 HMB	0.38mm	130°	1.50mm	1.80mm	3.00mm	38mm	Uncoated
7006-270450	UMDLX 0038 S30 HMP700	0.38mm	130°	1.50mm	1.80mm	3.00mm	38mm	HMP700
7006-270451	UMDLX 0039 S30 HMB	0.39mm	130°	1.50mm	1.80mm	3.00mm	38mm	Uncoated
7006-270452	UMDLX 0039 S30 HMP700	0.39mm	130°	1.50mm	1.80mm	3.00mm	38mm	HMP700

Twist Drills - Solid Carbide with Reinforced Shank

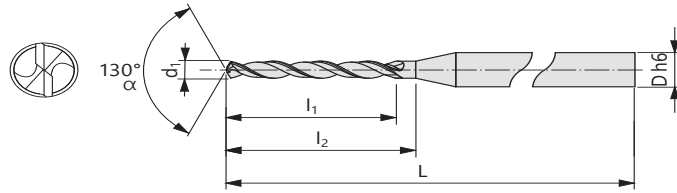

6-8×d₁
 < Ø 0.45
 4-5×d₁

Symbols Key (Pages 4 & 5)

UMDLX ...
 Point relief: 4 facet, 130° With x-point for self-centering

Item No.	Description	d ₁ Flute Ø	α Drill Point Angle	l ₁ Flute Length	l ₂ Neck Length	D h6 Shank Ø	L OAL	Coating
7006-270453	UMDLX 0040 S30 HMB	0.40mm	130°	2.00mm	2.40mm	3.00mm	38mm	Uncoated
7006-270454	UMDLX 0040 S30 HMP700	0.40mm	130°	2.00mm	2.40mm	3.00mm	38mm	HMP700
7006-270455	UMDLX 0041 S30 HMB	0.41mm	130°	2.00mm	2.40mm	3.00mm	38mm	Uncoated
7006-270456	UMDLX 0041 S30 HMP700	0.41mm	130°	2.00mm	2.40mm	3.00mm	38mm	HMP700
7006-270457	UMDLX 0042 S30 HMB	0.42mm	130°	2.00mm	2.40mm	3.00mm	38mm	Uncoated
7006-270458	UMDLX 0042 S30 HMP700	0.42mm	130°	2.00mm	2.40mm	3.00mm	38mm	HMP700
7006-270459	UMDLX 0043 S30 HMB	0.43mm	130°	2.00mm	2.40mm	3.00mm	38mm	Uncoated
7006-270460	UMDLX 0043 S30 HMP700	0.43mm	130°	2.00mm	2.40mm	3.00mm	38mm	HMP700
7006-270461	UMDLX 0044 S30 HMB	0.44mm	130°	2.00mm	2.40mm	3.00mm	38mm	Uncoated
7006-270462	UMDLX 0044 S30 HMP700	0.44mm	130°	2.00mm	2.40mm	3.00mm	38mm	HMP700
7006-270463	UMDLX 0045 S30 HMB	0.45mm	130°	3.50mm	4.00mm	3.00mm	38mm	Uncoated
7006-270464	UMDLX 0045 S30 HMP700	0.45mm	130°	3.50mm	4.00mm	3.00mm	38mm	HMP700
7006-270465	UMDLX 0046 S30 HMB	0.46mm	130°	3.50mm	4.00mm	3.00mm	38mm	Uncoated
7006-270466	UMDLX 0046 S30 HMP700	0.46mm	130°	3.50mm	4.00mm	3.00mm	38mm	HMP700
7006-270467	UMDLX 0047 S30 HMB	0.47mm	130°	3.50mm	4.00mm	3.00mm	38mm	Uncoated
7006-270468	UMDLX 0047 S30 HMP700	0.47mm	130°	3.50mm	4.00mm	3.00mm	38mm	HMP700
7006-270469	UMDLX 0048 S30 HMB	0.48mm	130°	3.50mm	4.00mm	3.00mm	38mm	Uncoated
7006-270470	UMDLX 0048 S30 HMP700	0.48mm	130°	3.50mm	4.00mm	3.00mm	38mm	HMP700
7006-270471	UMDLX 0049 S30 HMB	0.49mm	130°	4.00mm	4.60mm	3.00mm	38mm	Uncoated
7006-270472	UMDLX 0049 S30 HMP700	0.49mm	130°	4.00mm	4.60mm	3.00mm	38mm	HMP700
7006-270473	UMDLX 0050 S30 HMB	0.50mm	130°	4.00mm	4.60mm	3.00mm	38mm	Uncoated
7006-270474	UMDLX 0050 S30 HMP700	0.50mm	130°	4.00mm	4.60mm	3.00mm	38mm	HMP700
7006-270475	UMDLX 0051 S30 HMB	0.51mm	130°	4.00mm	4.60mm	3.00mm	38mm	Uncoated
7006-270476	UMDLX 0051 S30 HMP700	0.51mm	130°	4.00mm	4.60mm	3.00mm	38mm	HMP700
7006-270477	UMDLX 0052 S30 HMB	0.52mm	130°	4.00mm	4.60mm	3.00mm	38mm	Uncoated
7006-270478	UMDLX 0052 S30 HMP700	0.52mm	130°	4.00mm	4.60mm	3.00mm	38mm	HMP700
7006-270479	UMDLX 0053 S30 HMB	0.53mm	130°	4.00mm	4.60mm	3.00mm	38mm	Uncoated
7006-270480	UMDLX 0053 S30 HMP700	0.53mm	130°	4.00mm	4.60mm	3.00mm	38mm	HMP700
7006-270481	UMDLX 0054 S30 HMB	0.54mm	130°	4.50mm	5.10mm	3.00mm	38mm	Uncoated
7006-270482	UMDLX 0054 S30 HMP700	0.54mm	130°	4.50mm	5.10mm	3.00mm	38mm	HMP700
7006-270483	UMDLX 0055 S30 HMB	0.55mm	130°	4.50mm	5.1mm	3.00mm	38mm	Uncoated
7006-270484	UMDLX 0055 S30 HMP700	0.55mm	130°	4.50mm	5.10mm	3.00mm	38mm	HMP700
7006-270485	UMDLX 0056 S30 HMB	0.56mm	130°	4.50mm	5.10mm	3.00mm	38mm	Uncoated
7006-270486	UMDLX 0056 S30 HMP700	0.56mm	130°	4.50mm	5.10mm	3.00mm	38mm	HMP700
7006-270487	UMDLX 0057 S30 HMB	0.57mm	130°	4.50mm	5.10mm	3.00mm	38mm	Uncoated
7006-270488	UMDLX 0057 S30 HMP700	0.57mm	130°	4.50mm	5.10mm	3.00mm	38mm	HMP700
7006-270489	UMDLX 0058 S30 HMB	0.58mm	130°	4.50mm	5.10mm	3.00mm	38mm	Uncoated
7006-270490	UMDLX 0058 S30 HMP700	0.58mm	130°	4.50mm	5.10mm	3.00mm	38mm	HMP700
7006-270491	UMDLX 0059 S30 HMB	0.59mm	130°	4.50mm	5.10mm	3.00mm	38mm	Uncoated
7006-270492	UMDLX 0059 S30 HMP700	0.59mm	130°	4.50mm	5.10mm	3.00mm	38mm	HMP700
7006-270493	UMDLX 0060 S30 HMB	0.60mm	130°	4.50mm	5.10mm	3.00mm	38mm	Uncoated
7006-270494	UMDLX 0060 S30 HMP700	0.60mm	130°	4.50mm	5.10mm	3.00mm	38mm	HMP700
7006-270495	UMDLX 0061 S30 HMB	0.61mm	130°	5.00mm	5.70mm	3.00mm	38mm	Uncoated
7006-270496	UMDLX 0061 S30 HMP700	0.61mm	130°	5.00mm	5.70mm	3.00mm	38mm	HMP700
7006-270497	UMDLX 0062 S30 HMB	0.62mm	130°	5.00mm	5.70mm	3.00mm	38mm	Uncoated
7006-270498	UMDLX 0062 S30 HMP700	0.62mm	130°	5.00mm	5.70mm	3.00mm	38mm	HMP700
7006-270499	UMDLX 0063 S30 HMB	0.63mm	130°	5.00mm	5.70mm	3.00mm	38mm	Uncoated
7006-270500	UMDLX 0063 S30 HMP700	0.63mm	130°	5.00mm	5.70mm	3.00mm	38mm	HMP700
7006-270501	UMDLX 0064 S30 HMB	0.64mm	130°	5.00mm	5.70mm	3.00mm	38mm	Uncoated
7006-270502	UMDLX 0064 S30 HMP700	0.64mm	130°	5.00mm	5.70mm	3.00mm	38mm	HMP700
7006-270503	UMDLX 0065 S30 HMB	0.65mm	130°	5.00mm	5.70mm	3.00mm	38mm	Uncoated
7006-270504	UMDLX 0065 S30 HMP700	0.65mm	130°	5.00mm	5.70mm	3.00mm	38mm	HMP700

Twist Drills - Solid Carbide with Reinforced Shank

UTILIS
u-drill

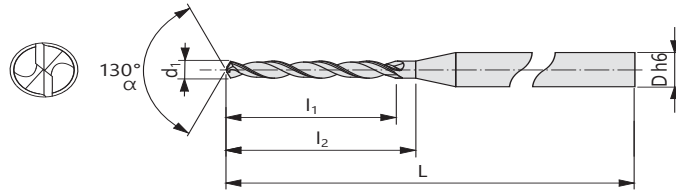

6-8 × d₁
 $< \varnothing 0.45$
 $4-5 \times d_1$

35°
130°

Symbols Key (Pages 4 & 5)

UMDLX ...

Point relief: 4 facet, 130° With x-point for self-centering

Item No.	Description	d ₁ Flute Ø	α Drill Point Angle	l ₁ Flute Length	l ₂ Neck Length	D h6 Shank Ø	L OAL	Coating
7006-270505	UMDLX 0066 S30 HMB	0.66mm	130°	5.00mm	5.70mm	3.00mm	38mm	Uncoated
7006-270506	UMDLX 0066 S30 HMP700	0.66mm	130°	5.00mm	5.70mm	3.00mm	38mm	HMP700
7006-270507	UMDLX 0067 S30 HMB	0.67mm	130°	5.00mm	5.70mm	3.00mm	38mm	Uncoated
7006-270508	UMDLX 0067 S30 HMP700	0.67mm	130°	5.00mm	5.70mm	3.00mm	38mm	HMP700
7006-270509	UMDLX 0068 S30 HMB	0.68mm	130°	5.50mm	6.20mm	3.00mm	38mm	Uncoated
7006-270510	UMDLX 0068 S30 HMP700	0.68mm	130°	5.50mm	6.20mm	3.00mm	38mm	HMP700
7006-270511	UMDLX 0069 S30 HMB	0.69mm	130°	5.60mm	6.30mm	3.00mm	38mm	Uncoated
7006-270512	UMDLX 0069 S30 HMP700	0.69mm	130°	5.60mm	6.30mm	3.00mm	38mm	HMP700
7006-270513	UMDLX 0070 S30 HMB	0.70mm	130°	5.60mm	6.30mm	3.00mm	38mm	Uncoated
7006-270514	UMDLX 0070 S30 HMP700	0.70mm	130°	5.60mm	6.30mm	3.00mm	38mm	HMP700
7006-270515	UMDLX 0071 S30 HMB	0.71mm	130°	5.60mm	6.30mm	3.00mm	38mm	Uncoated
7006-270516	UMDLX 0071 S30 HMP700	0.71mm	130°	5.60mm	6.30mm	3.00mm	38mm	HMP700
7006-270517	UMDLX 0072 S30 HMB	0.72mm	130°	5.60mm	6.30mm	3.00mm	38mm	Uncoated
7006-270518	UMDLX 0072 S30 HMP700	0.72mm	130°	5.60mm	6.30mm	3.00mm	38mm	HMP700
7006-270519	UMDLX 0073 S30 HMB	0.73mm	130°	5.60mm	6.30mm	3.00mm	38mm	Uncoated
7006-270520	UMDLX 0073 S30 HMP700	0.73mm	130°	5.60mm	6.30mm	3.00mm	38mm	HMP700
7006-270521	UMDLX 0074 S30 HMB	0.74mm	130°	5.60mm	6.30mm	3.00mm	38mm	Uncoated
7006-270522	UMDLX 0074 S30 HMP700	0.74mm	130°	5.60mm	6.30mm	3.00mm	38mm	HMP700
7006-270523	UMDLX 0075 S30 HMB	0.75mm	130°	5.60mm	6.30mm	3.00mm	38mm	Uncoated
7006-270524	UMDLX 0075 S30 HMP700	0.75mm	130°	5.60mm	6.30mm	3.00mm	38mm	HMP700
7006-270525	UMDLX 0076 S30 HMB	0.76mm	130°	6.50mm	7.30mm	3.00mm	38mm	Uncoated
7006-270526	UMDLX 0076 S30 HMP700	0.76mm	130°	6.50mm	7.30mm	3.00mm	38mm	HMP700
7006-270527	UMDLX 0077 S30 HMB	0.77mm	130°	6.50mm	7.30mm	3.00mm	38mm	Uncoated
7006-270528	UMDLX 0077 S30 HMP700	0.77mm	130°	6.50mm	7.30mm	3.00mm	38mm	HMP700
7006-270529	UMDLX 0078 S30 HMB	0.78mm	130°	6.50mm	7.30mm	3.00mm	38mm	Uncoated
7006-270530	UMDLX 0078 S30 HMP700	0.78mm	130°	6.50mm	7.30mm	3.00mm	38mm	HMP700
7006-270531	UMDLX 0079 S30 HMB	0.79mm	130°	6.50mm	7.30mm	3.00mm	38mm	Uncoated
7006-270532	UMDLX 0079 S30 HMP700	0.79mm	130°	6.50mm	7.30mm	3.00mm	38mm	HMP700
7006-270533	UMDLX 0080 S30 HMB	0.80mm	130°	6.50mm	7.30mm	3.00mm	38mm	Uncoated
7006-270534	UMDLX 0080 S30 HMP700	0.80mm	130°	6.50mm	7.30mm	3.00mm	38mm	HMP700
7006-270535	UMDLX 0081 S30 HMB	0.81mm	130°	6.50mm	7.30mm	3.00mm	38mm	Uncoated
7006-270536	UMDLX 0081 S30 HMP700	0.81mm	130°	6.50mm	7.30mm	3.00mm	38mm	HMP700
7006-270537	UMDLX 0082 S30 HMB	0.82mm	130°	6.50mm	7.30mm	3.00mm	38mm	Uncoated
7006-270538	UMDLX 0082 S30 HMP700	0.82mm	130°	6.50mm	7.30mm	3.00mm	38mm	HMP700
7006-270539	UMDLX 0083 S30 HMB	0.83mm	130°	6.50mm	7.30mm	3.00mm	38mm	Uncoated
7006-270540	UMDLX 0083 S30 HMP700	0.83mm	130°	6.50mm	7.30mm	3.00mm	38mm	HMP700
7006-270541	UMDLX 0084 S30 HMB	0.84mm	130°	6.50mm	7.30mm	3.00mm	38mm	Uncoated
7006-270542	UMDLX 0084 S30 HMP700	0.84mm	130°	6.50mm	7.30mm	3.00mm	38mm	HMP700
7006-270543	UMDLX 0085 S30 HMB	0.85mm	130°	6.50mm	7.30mm	3.00mm	38mm	Uncoated
7006-270544	UMDLX 0085 S30 HMP700	0.85mm	130°	6.50mm	7.30mm	3.00mm	38mm	HMP700
7006-270545	UMDLX 0086 S30 HMB	0.86mm	130°	7.00mm	7.90mm	3.00mm	38mm	Uncoated
7006-270546	UMDLX 0086 S30 HMP700	0.86mm	130°	7.00mm	7.90mm	3.00mm	38mm	HMP700
7006-270547	UMDLX 0087 S30 HMB	0.87mm	130°	7.00mm	7.90mm	3.00mm	38mm	Uncoated
7006-270548	UMDLX 0087 S30 HMP700	0.87mm	130°	7.00mm	7.90mm	3.00mm	38mm	HMP700
7006-270549	UMDLX 0088 S30 HMB	0.88mm	130°	7.00mm	7.90mm	3.00mm	38mm	Uncoated
7006-270550	UMDLX 0088 S30 HMP700	0.88mm	130°	7.00mm	7.90mm	3.00mm	38mm	HMP700
7006-270551	UMDLX 0089 S30 HMB	0.89mm	130°	7.00mm	7.90mm	3.00mm	38mm	Uncoated
7006-270552	UMDLX 0089 S30 HMP700	0.89mm	130°	7.00mm	7.90mm	3.00mm	38mm	HMP700
7006-270553	UMDLX 0090 S30 HMB	0.90mm	130°	7.00mm	7.90mm	3.00mm	38mm	Uncoated
7006-270554	UMDLX 0090 S30 HMP700	0.90mm	130°	7.00mm	7.90mm	3.00mm	38mm	HMP700

Twist Drills - Solid Carbide with Reinforced Shank

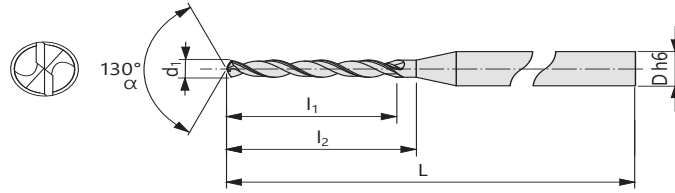

6-8×d₁
 < Ø 0.45
 4-5×d₁

Symbols Key (Pages 4 & 5)

UMDLX ...

Point relief: 4 facet, 130° With x-point for self-centering

Item No.	Description	d ₁ Flute Ø	α Drill Point Angle	L ₁ Flute Length	L ₂ Neck Length	D h6 Shank Ø	L OAL	Coating
7006-270555	UMDLX 0091 S30 HMB	0.91mm	130°	7.00mm	7.90mm	3.00mm	38mm	Uncoated
7006-270556	UMDLX 0091 S30 HMP700	0.91mm	130°	7.00mm	7.90mm	3.00mm	38mm	HMP700
7006-270557	UMDLX 0092 S30 HMB	0.92mm	130°	7.00mm	7.90mm	3.00mm	38mm	Uncoated
7006-270558	UMDLX 0092 S30 HMP700	0.92mm	130°	7.00mm	7.90mm	3.00mm	38mm	HMP700
7006-270559	UMDLX 0093 S30 HMB	0.93mm	130°	7.00mm	7.90mm	3.00mm	38mm	Uncoated
7006-270560	UMDLX 0093 S30 HMP700	0.93mm	130°	7.00mm	7.90mm	3.00mm	38mm	HMP700
7006-270561	UMDLX 0094 S30 HMB	0.94mm	130°	7.00mm	7.90mm	3.00mm	38mm	Uncoated
7006-270562	UMDLX 0094 S30 HMP700	0.94mm	130°	7.00mm	7.90mm	3.00mm	38mm	HMP700
7006-270563	UMDLX 0095 S30 HMB	0.95mm	130°	7.00mm	7.90mm	3.00mm	38mm	Uncoated
7006-270564	UMDLX 0095 S30 HMP700	0.95mm	130°	7.00mm	7.90mm	3.00mm	38mm	HMP700
7006-270565	UMDLX 0096 S30 HMB	0.96mm	130°	8.00mm	9.00mm	3.00mm	38mm	Uncoated
7006-270566	UMDLX 0096 S30 HMP700	0.96mm	130°	8.00mm	9.00mm	3.00mm	38mm	HMP700
7006-270567	UMDLX 0097 S30 HMB	0.97mm	130°	8.00mm	9.00mm	3.00mm	38mm	Uncoated
7006-270568	UMDLX 0097 S30 HMP700	0.97mm	130°	8.00mm	9.00mm	3.00mm	38mm	HMP700
7006-270569	UMDLX 0098 S30 HMB	0.98mm	130°	8.00mm	9.00mm	3.00mm	38mm	Uncoated
7006-270570	UMDLX 0098 S30 HMP700	0.98mm	130°	8.00mm	9.00mm	3.00mm	38mm	HMP700
7006-270571	UMDLX 0099 S30 HMB	0.99mm	130°	8.00mm	9.00mm	3.00mm	38mm	Uncoated
7006-270572	UMDLX 0099 S30 HMP700	0.99mm	130°	8.00mm	9.00mm	3.00mm	38mm	HMP700
7006-270573	UMDLX 0100 S30 HMB	1.00mm	130°	9.00mm	10.10mm	3.00mm	38mm	Uncoated
7006-270574	UMDLX 0100 S30 HMP700	1.00mm	130°	9.00mm	10.10mm	3.00mm	38mm	HMP700
7006-270575	UMDLX 0101 S30 HMB	1.01mm	130°	9.00mm	10.10mm	3.00mm	38mm	Uncoated
7006-270576	UMDLX 0101 S30 HMP700	1.01mm	130°	9.00mm	10.10mm	3.00mm	38mm	HMP700
7006-270577	UMDLX 0102 S30 HMB	1.02mm	130°	9.00mm	10.10mm	3.00mm	38mm	Uncoated
7006-270578	UMDLX 0102 S30 HMP700	1.02mm	130°	9.00mm	10.10mm	3.00mm	38mm	HMP700
7006-270579	UMDLX 0103 S30 HMB	1.03mm	130°	9.00mm	10.10mm	3.00mm	38mm	Uncoated
7006-270580	UMDLX 0103 S30 HMP700	1.03mm	130°	9.00mm	10.10mm	3.00mm	38mm	HMP700
7006-270581	UMDLX 0104 S30 HMB	1.04mm	130°	9.00mm	10.10mm	3.00mm	38mm	Uncoated
7006-270582	UMDLX 0104 S30 HMP700	1.04mm	130°	9.00mm	10.10mm	3.00mm	38mm	HMP700
7006-270583	UMDLX 0105 S30 HMB	1.05mm	130°	9.00mm	10.10mm	3.00mm	38mm	Uncoated
7006-270584	UMDLX 0105 S30 HMP700	1.05mm	130°	9.00mm	10.10mm	3.00mm	38mm	HMP700
7006-270585	UMDLX 0106 S30 HMB	1.06mm	130°	9.00mm	10.10mm	3.00mm	38mm	Uncoated
7006-270586	UMDLX 0106 S30 HMP700	1.06mm	130°	9.00mm	10.10mm	3.00mm	38mm	HMP700
7006-270587	UMDLX 0107 S30 HMB	1.07mm	130°	9.00mm	10.10mm	3.00mm	38mm	Uncoated
7006-270588	UMDLX 0107 S30 HMP700	1.07mm	130°	9.00mm	10.10mm	3.00mm	38mm	HMP700
7006-270589	UMDLX 0108 S30 HMB	1.08mm	130°	9.00mm	10.10mm	3.00mm	38mm	Uncoated
7006-270590	UMDLX 0108 S30 HMP700	1.08mm	130°	9.00mm	10.10mm	3.00mm	38mm	HMP700
7006-270591	UMDLX 0109 S30 HMB	1.09mm	130°	9.00mm	10.10mm	3.00mm	38mm	Uncoated
7006-270592	UMDLX 0109 S30 HMP700	1.09mm	130°	9.00mm	10.10mm	3.00mm	38mm	HMP700
7006-270593	UMDLX 0110 S30 HMB	1.10mm	130°	9.00mm	10.10mm	3.00mm	38mm	Uncoated
7006-270594	UMDLX 0110 S30 HMP700	1.10mm	130°	9.00mm	10.10mm	3.00mm	38mm	HMP700
7006-270595	UMDLX 0111 S30 HMB	1.11mm	130°	9.00mm	10.10mm	3.00mm	38mm	Uncoated
7006-270596	UMDLX 0111 S30 HMP700	1.11mm	130°	9.00mm	10.10mm	3.00mm	38mm	HMP700
7006-270597	UMDLX 0112 S30 HMB	1.12mm	130°	9.00mm	10.10mm	3.00mm	38mm	Uncoated
7006-270598	UMDLX 0112 S30 HMP700	1.12mm	130°	9.00mm	10.10mm	3.00mm	38mm	HMP700
7006-270599	UMDLX 0113 S30 HMB	1.13mm	130°	9.00mm	10.10mm	3.00mm	38mm	Uncoated
7006-270600	UMDLX 0113 S30 HMP700	1.13mm	130°	9.00mm	10.10mm	3.00mm	38mm	HMP700
7006-270601	UMDLX 0114 S30 HMB	1.14mm	130°	9.00mm	10.10mm	3.00mm	38mm	Uncoated
7006-270602	UMDLX 0114 S30 HMP700	1.14mm	130°	9.00mm	10.10mm	3.00mm	38mm	HMP700
7006-270603	UMDLX 0115 S30 HMB	1.15mm	130°	9.00mm	10.10mm	3.00mm	38mm	Uncoated
7006-270604	UMDLX 0115 S30 HMP700	1.15mm	130°	9.00mm	10.10mm	3.00mm	38mm	HMP700

Twist Drills - Solid Carbide with Reinforced Shank

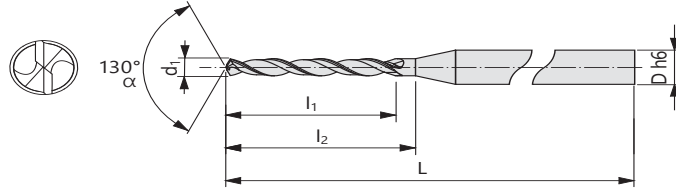

6-8×d₁
 < Ø 0.45
 4-5×d₁

35°
 130°

Symbols Key (Pages 4 & 5)

UMDLX ...
 Point relief: 4 facet, 130° With x-point for self-centering

Item No.	Description	d ₁ Flute Ø	α Drill Point Angle	L ₁ Flute Length	L ₂ Neck Length	D h6 Shank Ø	L OAL	Coating
7006-270605	UMDLX 0116 S30 HMB	1.16mm	130°	9.00mm	10.10mm	3.00mm	38mm	Uncoated
7006-270606	UMDLX 0116 S30 HMP700	1.16mm	130°	9.00mm	10.10mm	3.00mm	38mm	HMP700
7006-270607	UMDLX 0117 S30 HMB	1.17mm	130°	9.00mm	10.10mm	3.00mm	38mm	Uncoated
7006-270608	UMDLX 0117 S30 HMP700	1.17mm	130°	9.00mm	10.10mm	3.00mm	38mm	HMP700
7006-270609	UMDLX 0118 S30 HMB	1.18mm	130°	9.00mm	10.10mm	3.00mm	38mm	Uncoated
7006-270610	UMDLX 0118 S30 HMP700	1.18mm	130°	9.00mm	10.10mm	3.00mm	38mm	HMP700
7006-270611	UMDLX 0119 S30 HMB	1.19mm	130°	10.00mm	11.20mm	3.00mm	38mm	Uncoated
7006-270612	UMDLX 0119 S30 HMP700	1.19mm	130°	10.00mm	11.20mm	3.00mm	38mm	HMP700
7006-270613	UMDLX 0120 S30 HMB	1.20mm	130°	10.00mm	11.20mm	3.00mm	38mm	Uncoated
7006-270614	UMDLX 0120 S30 HMP700	1.20mm	130°	10.00mm	11.20mm	3.00mm	38mm	HMP700
7006-270615	UMDLX 0121 S30 HMB	1.21mm	130°	10.00mm	11.20mm	3.00mm	38mm	Uncoated
7006-270616	UMDLX 0121 S30 HMP700	1.21mm	130°	10.00mm	11.20mm	3.00mm	38mm	HMP700
7006-270617	UMDLX 0122 S30 HMB	1.22mm	130°	10.00mm	11.20mm	3.00mm	38mm	Uncoated
7006-270618	UMDLX 0122 S30 HMP700	1.22mm	130°	10.00mm	11.20mm	3.00mm	38mm	HMP700
7006-270619	UMDLX 0123 S30 HMB	1.23mm	130°	10.00mm	11.20mm	3.00mm	38mm	Uncoated
7006-270620	UMDLX 0123 S30 HMP700	1.23mm	130°	10.00mm	11.20mm	3.00mm	38mm	HMP700
7006-270621	UMDLX 0124 S30 HMB	1.24mm	130°	10.00mm	11.20mm	3.00mm	38mm	Uncoated
7006-270622	UMDLX 0124 S30 HMP700	1.24mm	130°	10.00mm	11.20mm	3.00mm	38mm	HMP700
7006-270623	UMDLX 0125 S30 HMB	1.25mm	130°	10.00mm	11.20mm	3.00mm	38mm	Uncoated
7006-270624	UMDLX 0125 S30 HMP700	1.25mm	130°	10.00mm	11.20mm	3.00mm	38mm	HMP700
7006-270625	UMDLX 0126 S30 HMB	1.26mm	130°	10.00mm	11.20mm	3.00mm	38mm	Uncoated
7006-270626	UMDLX 0126 S30 HMP700	1.26mm	130°	10.00mm	11.20mm	3.00mm	38mm	HMP700
7006-270627	UMDLX 0127 S30 HMB	1.27mm	130°	10.00mm	11.20mm	3.00mm	38mm	Uncoated
7006-270628	UMDLX 0127 S30 HMP700	1.27mm	130°	10.00mm	11.20mm	3.00mm	38mm	HMP700
7006-270629	UMDLX 0128 S30 HMB	1.28mm	130°	10.00mm	11.20mm	3.00mm	38mm	Uncoated
7006-270630	UMDLX 0128 S30 HMP700	1.28mm	130°	10.00mm	11.20mm	3.00mm	38mm	HMP700
7006-270631	UMDLX 0129 S30 HMB	1.29mm	130°	10.00mm	11.20mm	3.00mm	38mm	Uncoated
7006-270632	UMDLX 0129 S30 HMP700	1.29mm	130°	10.00mm	11.20mm	3.00mm	38mm	HMP700
7006-270633	UMDLX 0130 S30 HMB	1.30mm	130°	10.00mm	11.20mm	3.00mm	38mm	Uncoated
7006-270634	UMDLX 0130 S30 HMP700	1.30mm	130°	10.00mm	11.20mm	3.00mm	38mm	HMP700
7006-270635	UMDLX 0131 S30 HMB	1.31mm	130°	10.00mm	11.20mm	3.00mm	38mm	Uncoated
7006-270636	UMDLX 0131 S30 HMP700	1.31mm	130°	10.00mm	11.20mm	3.00mm	38mm	HMP700
7006-270637	UMDLX 0132 S30 HMB	1.32mm	130°	10.00mm	11.20mm	3.00mm	38mm	Uncoated
7006-270638	UMDLX 0132 S30 HMP700	1.32mm	130°	10.00mm	11.20mm	3.00mm	38mm	HMP700
7006-270639	UMDLX 0133 S30 HMB	1.33mm	130°	11.50mm	12.80mm	3.00mm	38mm	Uncoated
7006-270640	UMDLX 0133 S30 HMP700	1.33mm	130°	11.50mm	12.80mm	3.00mm	38mm	HMP700
7006-270641	UMDLX 0134 S30 HMB	1.34mm	130°	11.50mm	12.80mm	3.00mm	38mm	Uncoated
7006-270642	UMDLX 0134 S30 HMP700	1.34mm	130°	11.50mm	12.80mm	3.00mm	38mm	HMP700
7006-270643	UMDLX 0135 S30 HMB	1.35mm	130°	11.50mm	12.80mm	3.00mm	38mm	Uncoated
7006-270644	UMDLX 0135 S30 HMP700	1.35mm	130°	11.50mm	12.80mm	3.00mm	38mm	HMP700
7006-270645	UMDLX 0136 S30 HMB	1.36mm	130°	11.50mm	12.80mm	3.00mm	38mm	Uncoated
7006-270646	UMDLX 0136 S30 HMP700	1.36mm	130°	11.50mm	12.80mm	3.00mm	38mm	HMP700
7006-270647	UMDLX 0137 S30 HMB	1.37mm	130°	11.50mm	12.80mm	3.00mm	38mm	Uncoated
7006-270648	UMDLX 0137 S30 HMP700	1.37mm	130°	11.50mm	12.80mm	3.00mm	38mm	HMP700
7006-270649	UMDLX 0138 S30 HMB	1.38mm	130°	11.50mm	12.80mm	3.00mm	38mm	Uncoated
7006-270650	UMDLX 0138 S30 HMP700	1.38mm	130°	11.50mm	12.80mm	3.00mm	38mm	HMP700
7006-270651	UMDLX 0139 S30 HMB	1.39mm	130°	11.50mm	12.80mm	3.00mm	38mm	Uncoated
7006-270652	UMDLX 0139 S30 HMP700	1.39mm	130°	11.50mm	12.80mm	3.00mm	38mm	HMP700
7006-270653	UMDLX 0140 S30 HMB	1.40mm	130°	11.50mm	12.80mm	3.00mm	38mm	Uncoated
7006-270654	UMDLX 0140 S30 HMP700	1.40mm	130°	11.50mm	12.80mm	3.00mm	38mm	HMP700

Twist Drills - Solid Carbide with Reinforced Shank

UTILIS
u-drill

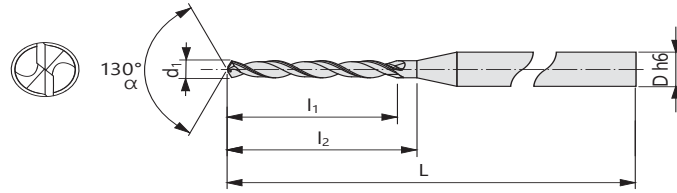

UMDLX ...

Point relief: 4 facet, 130° With x-point for self-centering

Item No.	Description	d ₁ Flute Ø	α Drill Point Angle	l ₁ Flute Length	l ₂ Neck Length	D h6 Shank Ø	L OAL	Coating
7006-270655	UMDLX 0141 S30 HMB	1.41mm	130°	11.50mm	12.80mm	3.00mm	38mm	Uncoated
7006-270656	UMDLX 0141 S30 HMP700	1.41mm	130°	11.50mm	12.80mm	3.00mm	38mm	HMP700
7006-270657	UMDLX 0142 S30 HMB	1.42mm	130°	11.50mm	12.80mm	3.00mm	38mm	Uncoated
7006-270658	UMDLX 0142 S30 HMP700	1.42mm	130°	11.50mm	12.80mm	3.00mm	38mm	HMP700
7006-270659	UMDLX 0143 S30 HMB	1.43mm	130°	11.50mm	12.80mm	3.00mm	38mm	Uncoated
7006-270660	UMDLX 0143 S30 HMP700	1.43mm	130°	11.50mm	12.80mm	3.00mm	38mm	HMP700
7006-270661	UMDLX 0144 S30 HMB	1.44mm	130°	11.50mm	12.80mm	3.00mm	38mm	Uncoated
7006-270662	UMDLX 0144 S30 HMP700	1.44mm	130°	11.50mm	12.80mm	3.00mm	38mm	HMP700
7006-270663	UMDLX 0145 S30 HMB	1.45mm	130°	11.50mm	12.80mm	3.00mm	38mm	Uncoated
7006-270664	UMDLX 0145 S30 HMP700	1.45mm	130°	11.50mm	12.80mm	3.00mm	38mm	HMP700
7006-270665	UMDLX 0146 S30 HMB	1.46mm	130°	11.50mm	12.80mm	3.00mm	38mm	Uncoated
7006-270666	UMDLX 0146 S30 HMP700	1.46mm	130°	11.50mm	12.80mm	3.00mm	38mm	HMP700
7006-270667	UMDLX 0147 S30 HMB	1.47mm	130°	11.50mm	12.80mm	3.00mm	38mm	Uncoated
7006-270668	UMDLX 0147 S30 HMP700	1.47mm	130°	11.50mm	12.80mm	3.00mm	38mm	HMP700
7006-270669	UMDLX 0148 S30 HMB	1.48mm	130°	11.50mm	12.80mm	3.00mm	38mm	Uncoated
7006-270670	UMDLX 0148 S30 HMP700	1.48mm	130°	11.50mm	12.80mm	3.00mm	38mm	HMP700
7006-270671	UMDLX 0149 S30 HMB	1.49mm	130°	11.50mm	12.80mm	3.00mm	38mm	Uncoated
7006-270672	UMDLX 0149 S30 HMP700	1.49mm	130°	11.50mm	12.80mm	3.00mm	38mm	HMP700
7006-270673	UMDLX 0150 S30 HMB	1.50mm	130°	11.50mm	12.80mm	3.00mm	38mm	Uncoated
7006-270674	UMDLX 0150 S30 HMP700	1.50mm	130°	11.50mm	12.80mm	3.00mm	38mm	HMP700
7006-270675	UMDLX 0151 S30 HMB	1.51mm	130°	12.00mm	13.40mm	3.00mm	38mm	Uncoated
7006-270676	UMDLX 0151 S30 HMP700	1.51mm	130°	12.00mm	13.40mm	3.00mm	38mm	HMP700
7006-270677	UMDLX 0152 S30 HMB	1.52mm	130°	12.00mm	13.40mm	3.00mm	38mm	Uncoated
7006-270678	UMDLX 0152 S30 HMP700	1.52mm	130°	12.00mm	13.40mm	3.00mm	38mm	HMP700
7006-270679	UMDLX 0153 S30 HMB	1.53mm	130°	12.00mm	13.40mm	3.00mm	38mm	Uncoated
7006-270680	UMDLX 0153 S30 HMP700	1.53mm	130°	12.00mm	13.40mm	3.00mm	38mm	HMP700
7006-270681	UMDLX 0154 S30 HMB	1.54mm	130°	12.00mm	13.40mm	3.00mm	38mm	Uncoated
7006-270682	UMDLX 0154 S30 HMP700	1.54mm	130°	12.00mm	13.40mm	3.00mm	38mm	HMP700
7006-270683	UMDLX 0155 S30 HMB	1.55mm	130°	12.00mm	13.40mm	3.00mm	38mm	Uncoated
7006-270684	UMDLX 0155 S30 HMP700	1.55mm	130°	12.00mm	13.40mm	3.00mm	38mm	HMP700
7006-270685	UMDLX 0156 S30 HMB	1.56mm	130°	12.00mm	13.40mm	3.00mm	38mm	Uncoated
7006-270686	UMDLX 0156 S30 HMP700	1.56mm	130°	12.00mm	13.40mm	3.00mm	38mm	HMP700
7006-270687	UMDLX 0157 S30 HMB	1.57mm	130°	12.00mm	13.40mm	3.00mm	38mm	Uncoated
7006-270688	UMDLX 0157 S30 HMP700	1.57mm	130°	12.00mm	13.40mm	3.00mm	38mm	HMP700
7006-270689	UMDLX 0158 S30 HMB	1.58mm	130°	12.00mm	13.40mm	3.00mm	38mm	Uncoated
7006-270690	UMDLX 0158 S30 HMP700	1.58mm	130°	12.00mm	13.40mm	3.00mm	38mm	HMP700
7006-270691	UMDLX 0159 S30 HMB	1.59mm	130°	12.00mm	13.40mm	3.00mm	38mm	Uncoated
7006-270692	UMDLX 0159 S30 HMP700	1.59mm	130°	12.00mm	13.40mm	3.00mm	38mm	HMP700
7006-270693	UMDLX 0160 S30 HMB	1.60mm	130°	12.00mm	13.40mm	3.00mm	38mm	Uncoated
7006-270694	UMDLX 0160 S30 HMP700	1.60mm	130°	12.00mm	13.40mm	3.00mm	38mm	HMP700
7006-270695	UMDLX 0161 S30 HMB	1.61mm	130°	12.00mm	13.40mm	3.00mm	38mm	Uncoated
7006-270696	UMDLX 0161 S30 HMP700	1.61mm	130°	12.00mm	13.40mm	3.00mm	38mm	HMP700
7006-270697	UMDLX 0162 S30 HMB	1.62mm	130°	12.00mm	13.40mm	3.00mm	38mm	Uncoated
7006-270698	UMDLX 0162 S30 HMP700	1.62mm	130°	12.00mm	13.40mm	3.00mm	38mm	HMP700
7006-270699	UMDLX 0163 S30 HMB	1.63mm	130°	12.00mm	13.40mm	3.00mm	38mm	Uncoated
7006-270700	UMDLX 0163 S30 HMP700	1.63mm	130°	12.00mm	13.40mm	3.00mm	38mm	HMP700
7006-270701	UMDLX 0164 S30 HMB	1.64mm	130°	12.00mm	13.40mm	3.00mm	38mm	Uncoated
7006-270702	UMDLX 0164 S30 HMP700	1.64mm	130°	12.00mm	13.40mm	3.00mm	38mm	HMP700
7006-270703	UMDLX 0165 S30 HMB	1.65mm	130°	12.00mm	13.40mm	3.00mm	38mm	Uncoated
7006-270704	UMDLX 0165 S30 HMP700	1.65mm	130°	12.00mm	13.40mm	3.00mm	38mm	HMP700

Twist Drills - Solid Carbide with Reinforced Shank

UTILIS
u-drill

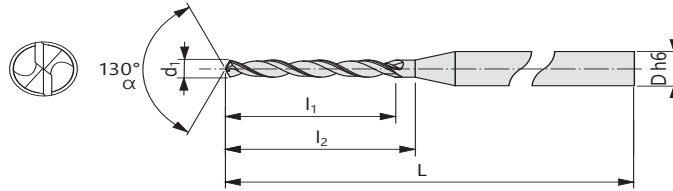

UMDLX ...

Point relief: 4 facet, 130° With x-point for self-centering

Item No.	Description	d ₁ Flute Ø	α Drill Point Angle	l ₁ Flute Length	l ₂ Neck Length	D h6 Shank Ø	L OAL	Coating
7006-270705	UMDLX 0166 S30 HMB	1.66mm	130°	12.00mm	13.40mm	3.00mm	38mm	Uncoated
7006-270706	UMDLX 0166 S30 HMP700	1.66mm	130°	12.00mm	13.40mm	3.00mm	38mm	HMP700
7006-270707	UMDLX 0167 S30 HMB	1.67mm	130°	12.00mm	13.40mm	3.00mm	38mm	Uncoated
7006-270708	UMDLX 0167 S30 HMP700	1.67mm	130°	12.00mm	13.40mm	3.00mm	38mm	HMP700
7006-270709	UMDLX 0168 S30 HMB	1.68mm	130°	12.00mm	13.40mm	3.00mm	38mm	Uncoated
7006-270710	UMDLX 0168 S30 HMP700	1.68mm	130°	12.00mm	13.40mm	3.00mm	38mm	HMP700
7006-270711	UMDLX 0169 S30 HMB	1.69mm	130°	12.00mm	13.40mm	3.00mm	38mm	Uncoated
7006-270712	UMDLX 0169 S30 HMP700	1.69mm	130°	12.00mm	13.40mm	3.00mm	38mm	HMP700
7006-270713	UMDLX 0170 S30 HMB	1.70mm	130°	12.00mm	13.40mm	3.00mm	38mm	Uncoated
7006-270714	UMDLX 0170 S30 HMP700	1.70mm	130°	12.00mm	13.40mm	3.00mm	38mm	HMP700
7006-270715	UMDLX 0171 S30 HMB	1.71mm	130°	12.00mm	13.40mm	3.00mm	38mm	Uncoated
7006-270716	UMDLX 0171 S30 HMP700	1.71mm	130°	12.00mm	13.40mm	3.00mm	38mm	HMP700
7006-270717	UMDLX 0172 S30 HMB	1.72mm	130°	12.00mm	13.40mm	3.00mm	38mm	Uncoated
7006-270718	UMDLX 0172 S30 HMP700	1.72mm	130°	12.00mm	13.40mm	3.00mm	38mm	HMP700
7006-270719	UMDLX 0173 S30 HMB	1.73mm	130°	12.00mm	13.40mm	3.00mm	38mm	Uncoated
7006-270720	UMDLX 0173 S30 HMP700	1.73mm	130°	12.00mm	13.40mm	3.00mm	38mm	HMP700
7006-270721	UMDLX 0174 S30 HMB	1.74mm	130°	12.00mm	13.40mm	3.00mm	38mm	Uncoated
7006-270722	UMDLX 0174 S30 HMP700	1.74mm	130°	12.00mm	13.40mm	3.00mm	38mm	HMP700
7006-270723	UMDLX 0175 S30 HMB	1.75mm	130°	12.00mm	13.40mm	3.00mm	38mm	Uncoated
7006-270724	UMDLX 0175 S30 HMP700	1.75mm	130°	12.00mm	13.40mm	3.00mm	38mm	HMP700
7006-270725	UMDLX 0176 S30 HMB	1.76mm	130°	12.00mm	13.40mm	3.00mm	38mm	Uncoated
7006-270726	UMDLX 0176 S30 HMP700	1.76mm	130°	12.00mm	13.40mm	3.00mm	38mm	HMP700
7006-270727	UMDLX 0177 S30 HMB	1.77mm	130°	12.00mm	13.40mm	3.00mm	38mm	Uncoated
7006-270728	UMDLX 0177 S30 HMP700	1.77mm	130°	12.00mm	13.40mm	3.00mm	38mm	HMP700
7006-270729	UMDLX 0178 S30 HMB	1.78mm	130°	12.00mm	13.40mm	3.00mm	38mm	Uncoated
7006-270730	UMDLX 0178 S30 HMP700	1.78mm	130°	12.00mm	13.40mm	3.00mm	38mm	HMP700
7006-270731	UMDLX 0179 S30 HMB	1.79mm	130°	12.00mm	13.40mm	3.00mm	38mm	Uncoated
7006-270732	UMDLX 0179 S30 HMP700	1.79mm	130°	12.00mm	13.40mm	3.00mm	38mm	HMP700
7006-270733	UMDLX 0180 S30 HMB	1.80mm	130°	12.00mm	13.40mm	3.00mm	38mm	Uncoated
7006-270734	UMDLX 0180 S30 HMP700	1.80mm	130°	12.00mm	13.40mm	3.00mm	38mm	HMP700
7006-270735	UMDLX 0181 S30 HMB	1.81mm	130°	12.00mm	13.40mm	3.00mm	38mm	Uncoated
7006-270736	UMDLX 0181 S30 HMP700	1.81mm	130°	12.00mm	13.40mm	3.00mm	38mm	HMP700
7006-270737	UMDLX 0182 S30 HMB	1.82mm	130°	12.00mm	13.40mm	3.00mm	38mm	Uncoated
7006-270738	UMDLX 0182 S30 HMP700	1.82mm	130°	12.00mm	13.40mm	3.00mm	38mm	HMP700
7006-270739	UMDLX 0183 S30 HMB	1.83mm	130°	12.00mm	13.40mm	3.00mm	38mm	Uncoated
7006-270740	UMDLX 0183 S30 HMP700	1.83mm	130°	12.00mm	13.40mm	3.00mm	38mm	HMP700
7006-270741	UMDLX 0184 S30 HMB	1.84mm	130°	12.00mm	13.40mm	3.00mm	38mm	Uncoated
7006-270742	UMDLX 0184 S30 HMP700	1.84mm	130°	12.00mm	13.40mm	3.00mm	38mm	HMP700
7006-270743	UMDLX 0185 S30 HMB	1.85mm	130°	12.00mm	13.40mm	3.00mm	38mm	Uncoated
7006-270744	UMDLX 0185 S30 HMP700	1.85mm	130°	12.00mm	13.40mm	3.00mm	38mm	HMP700
7006-270745	UMDLX 0186 S30 HMB	1.86mm	130°	12.00mm	13.40mm	3.00mm	38mm	Uncoated
7006-270746	UMDLX 0186 S30 HMP700	1.86mm	130°	12.00mm	13.40mm	3.00mm	38mm	HMP700
7006-270747	UMDLX 0187 S30 HMB	1.87mm	130°	12.00mm	13.40mm	3.00mm	38mm	Uncoated
7006-270748	UMDLX 0187 S30 HMP700	1.87mm	130°	12.00mm	13.40mm	3.00mm	38mm	HMP700
7006-270749	UMDLX 0188 S30 HMB	1.88mm	130°	12.00mm	13.40mm	3.00mm	38mm	Uncoated
7006-270750	UMDLX 0188 S30 HMP700	1.88mm	130°	12.00mm	13.40mm	3.00mm	38mm	HMP700
7006-270751	UMDLX 0189 S30 HMB	1.89mm	130°	12.00mm	13.40mm	3.00mm	38mm	Uncoated
7006-270752	UMDLX 0189 S30 HMP700	1.89mm	130°	12.00mm	13.40mm	3.00mm	38mm	HMP700
7006-270753	UMDLX 0190 S30 HMB	1.90mm	130°	12.00mm	13.40mm	3.00mm	38mm	Uncoated
7006-270754	UMDLX 0190 S30 HMP700	1.90mm	130°	12.00mm	13.40mm	3.00mm	38mm	HMP700

Twist Drills - Solid Carbide with Reinforced Shank

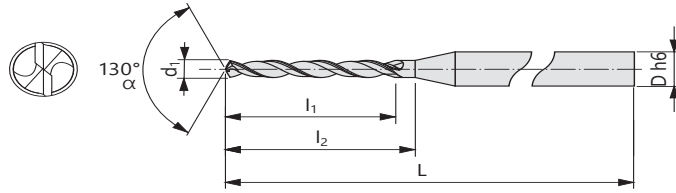

6-8 × d₁
 < Ø 0.45
 4-5 × d₁

Symbols Key (Pages 4 & 5)

UMDLX ...
 Point relief: 4 facet, 130° With x-point for self-centering

Item No.	Description	d ₁ Flute Ø	α Drill Point Angle	I ₁ Flute Length	I ₂ Neck Length	D h6 Shank Ø	L OAL	Coating
7006-270755	UMDLX 0191 S30 HMB	1.91mm	130°	12.0mm	13.40mm	3.00mm	38mm	Uncoated
7006-270756	UMDLX 0191 S30 HMP700	1.91mm	130°	12.0mm	13.40mm	3.00mm	38mm	HMP700
7006-270757	UMDLX 0192 S30 HMB	1.92mm	130°	12.0mm	13.40mm	3.00mm	38mm	Uncoated
7006-270758	UMDLX 0192 S30 HMP700	1.92mm	130°	12.0mm	13.40mm	3.00mm	38mm	HMP700
7006-270759	UMDLX 0193 S30 HMB	1.93mm	130°	12.0mm	13.40mm	3.00mm	38mm	Uncoated
7006-270760	UMDLX 0193 S30 HMP700	1.93mm	130°	12.0mm	13.40mm	3.00mm	38mm	HMP700
7006-270761	UMDLX 0194 S30 HMB	1.94mm	130°	12.0mm	13.40mm	3.00mm	38mm	Uncoated
7006-270762	UMDLX 0194 S30 HMP700	1.94mm	130°	12.0mm	13.40mm	3.00mm	38mm	HMP700
7006-270763	UMDLX 0195 S30 HMB	1.95mm	130°	12.0mm	13.40mm	3.00mm	38mm	Uncoated
7006-270764	UMDLX 0195 S30 HMP700	1.95mm	130°	12.0mm	13.40mm	3.00mm	38mm	HMP700
7006-270765	UMDLX 0196 S30 HMB	1.96mm	130°	12.0mm	13.40mm	3.00mm	38mm	Uncoated
7006-270766	UMDLX 0196 S30 HMP700	1.96mm	130°	12.0mm	13.40mm	3.00mm	38mm	HMP700
7006-270767	UMDLX 0197 S30 HMB	1.97mm	130°	12.0mm	13.40mm	3.00mm	38mm	Uncoated
7006-270768	UMDLX 0197 S30 HMP700	1.97mm	130°	12.0mm	13.40mm	3.00mm	38mm	HMP700
7006-270769	UMDLX 0198 S30 HMB	1.98mm	130°	12.0mm	13.40mm	3.00mm	38mm	Uncoated
7006-270770	UMDLX 0198 S30 HMP700	1.98mm	130°	12.0mm	13.40mm	3.00mm	38mm	HMP700
7006-270771	UMDLX 0199 S30 HMB	1.99mm	130°	12.0mm	13.40mm	3.00mm	38mm	Uncoated
7006-270772	UMDLX 0199 S30 HMP700	1.99mm	130°	12.0mm	13.40mm	3.00mm	38mm	HMP700
7006-270773	UMDLX 0200 S30 HMB	2.00mm	130°	12.0mm	13.40mm	3.00mm	38mm	Uncoated
7006-270774	UMDLX 0200 S30 HMP700	2.00mm	130°	12.0mm	13.40mm	3.00mm	38mm	HMP700
7006-270775	UMDLX 0205 S30 HMB	2.05mm	130°	15.0mm	16.70mm	3.00mm	50mm	Uncoated
7006-270776	UMDLX 0205 S30 HMP700	2.05mm	130°	15.0mm	16.70mm	3.00mm	50mm	HMP700
7006-270777	UMDLX 0210 S30 HMB	2.10mm	130°	15.0mm	16.70mm	3.00mm	50mm	Uncoated
7006-270778	UMDLX 0210 S30 HMP700	2.10mm	130°	15.0mm	16.70mm	3.00mm	50mm	HMP700
7006-270779	UMDLX 0215 S30 HMB	2.15mm	130°	15.0mm	16.70mm	3.00mm	50mm	Uncoated
7006-270780	UMDLX 0215 S30 HMP700	2.15mm	130°	15.0mm	16.70mm	3.00mm	50mm	HMP700
7006-270781	UMDLX 0220 S30 HMB	2.20mm	130°	15.0mm	16.70mm	3.00mm	50mm	Uncoated
7006-270782	UMDLX 0220 S30 HMP700	2.20mm	130°	15.0mm	16.70mm	3.00mm	50mm	HMP700
7006-270783	UMDLX 0225 S30 HMB	2.25mm	130°	15.0mm	16.70mm	3.00mm	50mm	Uncoated
7006-270784	UMDLX 0225 S30 HMP700	2.25mm	130°	15.0mm	16.70mm	3.00mm	50mm	HMP700
7006-270785	UMDLX 0230 S30 HMB	2.30mm	130°	15.0mm	16.70mm	3.00mm	50mm	Uncoated
7006-270786	UMDLX 0230 S30 HMP700	2.30mm	130°	15.0mm	16.70mm	3.00mm	50mm	HMP700
7006-270787	UMDLX 0235 S30 HMB	2.35mm	130°	15.0mm	16.70mm	3.00mm	50mm	Uncoated
7006-270788	UMDLX 0235 S30 HMP700	2.35mm	130°	15.0mm	16.70mm	3.00mm	50mm	HMP700
7006-270789	UMDLX 0240 S30 HMB	2.40mm	130°	15.0mm	16.70mm	3.00mm	50mm	Uncoated
7006-270790	UMDLX 0240 S30 HMP700	2.40mm	130°	15.0mm	16.70mm	3.00mm	50mm	HMP700
7006-270791	UMDLX 0245 S30 HMB	2.45mm	130°	15.0mm	16.70mm	3.00mm	50mm	Uncoated
7006-270792	UMDLX 0245 S30 HMP700	2.45mm	130°	15.0mm	16.70mm	3.00mm	50mm	HMP700
7006-270793	UMDLX 0250 S30 HMB	2.50mm	130°	15.0mm	16.70mm	3.00mm	50mm	Uncoated
7006-270794	UMDLX 0250 S30 HMP700	2.50mm	130°	15.0mm	16.70mm	3.00mm	50mm	HMP700
7006-270795	UMDLX 0255 S30 HMB	2.55mm	130°	18.0mm	20.00mm	3.00mm	50mm	Uncoated
7006-270796	UMDLX 0255 S30 HMP700	2.55mm	130°	18.0mm	20.00mm	3.00mm	50mm	HMP700
7006-270797	UMDLX 0260 S30 HMB	2.60mm	130°	18.0mm	20.00mm	3.00mm	50mm	Uncoated
7006-270798	UMDLX 0260 S30 HMP700	2.60mm	130°	18.0mm	20.00mm	3.00mm	50mm	HMP700
7006-270799	UMDLX 0265 S30 HMB	2.65mm	130°	18.0mm	20.00mm	3.00mm	50mm	Uncoated
7006-270800	UMDLX 0265 S30 HMP700	2.65mm	130°	18.0mm	20.00mm	3.00mm	50mm	HMP700
7006-270801	UMDLX 0270 S30 HMB	2.70mm	130°	18.0mm	20.00mm	3.00mm	50mm	Uncoated
7006-270802	UMDLX 0270 S30 HMP700	2.70mm	130°	18.0mm	20.00mm	3.00mm	50mm	HMP700
7006-270803	UMDLX 0275 S30 HMB	2.75mm	130°	18.0mm	20.00mm	3.00mm	50mm	Uncoated
7006-270804	UMDLX 0275 S30 HMP700	2.75mm	130°	18.0mm	20.00mm	3.00mm	50mm	HMP700

Twist Drills - Solid Carbide with Reinforced Shank

UTILIS
u-drill

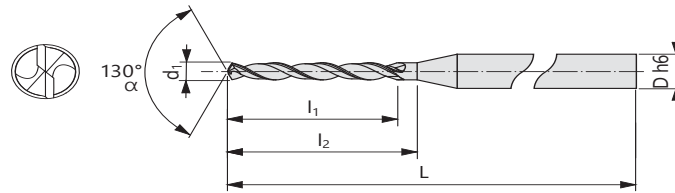

6-8×d₁
< Ø 0.45
4-5×d₁

Symbols Key (Pages 4 & 5)

UMDLX ...

Point relief: 4 facet, 130° With x-point for self-centering

Item No.	Description	d ₁ Flute Ø	α Drill Point Angle	l ₁ Flute Length	l ₂ Neck Length	D h6 Shank Ø	L OAL	Coating
7006-270805	UMDLX 0280 S30 HMB	2.80mm	130°	18.00mm	20.00mm	3.00mm	50mm	Uncoated
7006-270806	UMDLX 0280 S30 HMP700	2.80mm	130°	18.00mm	20.00mm	3.00mm	50mm	HMP700
7006-270807	UMDLX 0285 S30 HMB	2.85mm	130°	18.00mm	20.00mm	3.00mm	50mm	Uncoated
7006-270808	UMDLX 0285 S30 HMP700	2.85mm	130°	18.00mm	20.00mm	3.00mm	50mm	HMP700
7006-270809	UMDLX 0290 S30 HMB	2.90mm	130°	18.00mm	20.00mm	3.00mm	50mm	Uncoated
7006-270810	UMDLX 0290 S30 HMP700	2.90mm	130°	18.00mm	20.00mm	3.00mm	50mm	HMP700
7006-270811	UMDLX 0295 S30 HMB	2.95mm	130°	18.00mm	20.00mm	3.00mm	50mm	Uncoated
7006-270812	UMDLX 0295 S30 HMP700	2.95mm	130°	18.00mm	20.00mm	3.00mm	50mm	HMP700
7006-270813	UMDLX 0300 S30 HMB	3.00mm	130°	18.00mm	20.00mm	3.00mm	50mm	Uncoated
7006-270814	UMDLX 0300 S30 HMP700	3.00mm	130°	18.00mm	20.00mm	3.00mm	50mm	HMP700

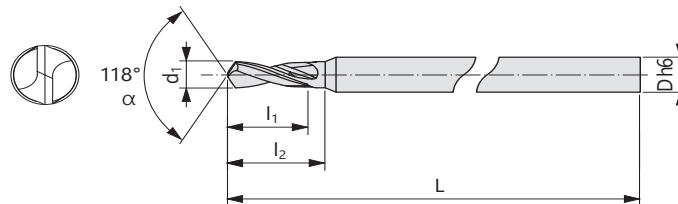

2-3×d₁

Symbols Key (Pages 4 & 5)

UMDS ...

Point relief: 4 facet, 118°

Item No.	Description	d ₁ Flute Ø	α Drill Point Angle	l ₁ Flute Length	l ₂ Neck Length	D h6 Shank Ø	L OAL	Coating
7006-270315	UMDS 0010 S10 HMB	0.10mm	118°	0.25mm	0.40mm	1.00mm	30mm	Uncoated
7006-270316	UMDS 0015 S10 HMB	0.15mm	118°	0.38mm	0.50mm	1.00mm	30mm	Uncoated
7006-270317	UMDS 0020 S10 HMB	0.20mm	118°	0.50mm	0.70mm	1.00mm	30mm	Uncoated
7006-270318	UMDS 0025 S10 HMB	0.25mm	118°	0.65mm	0.80mm	1.00mm	30mm	Uncoated
7006-270319	UMDS 0030 S10 HMB	0.30mm	118°	0.75mm	0.90mm	1.00mm	30mm	Uncoated
7006-270320	UMDS 0035 S10 HMB	0.35mm	118°	0.90mm	1.10mm	1.00mm	30mm	Uncoated
7006-270321	UMDS 0040 S10 HMB	0.40mm	118°	1.00mm	1.40mm	1.00mm	30mm	Uncoated
7006-270322	UMDS 0045 S10 HMB	0.45mm	118°	1.15mm	1.50mm	1.00mm	30mm	Uncoated
7006-270323	UMDS 0050 S10 HMB	0.50mm	118°	1.40mm	2.00mm	1.00mm	30mm	Uncoated
7006-270324	UMDS 0055 S10 HMB	0.55mm	118°	1.40mm	2.00mm	1.00mm	30mm	Uncoated
7006-270325	UMDS 0060 S10 HMB	0.60mm	118°	1.50mm	2.10mm	1.00mm	30mm	Uncoated
7006-270326	UMDS 0065 S10 HMB	0.65mm	118°	1.60mm	2.20mm	1.00mm	30mm	Uncoated
7006-270327	UMDS 0070 S10 HMB	0.70mm	118°	1.80mm	2.40mm	1.00mm	30mm	Uncoated
7006-270328	UMDS 0075 S10 HMB	0.75mm	118°	1.90mm	2.50mm	1.00mm	30mm	Uncoated
7006-270329	UMDS 0080 S15 HMB	0.80mm	118°	2.00mm	2.60mm	1.50mm	30mm	Uncoated
7006-270330	UMDS 0085 S15 HMB	0.85mm	118°	2.10mm	2.80mm	1.50mm	30mm	Uncoated
7006-270331	UMDS 0090 S15 HMB	0.90mm	118°	2.30mm	3.00mm	1.50mm	30mm	Uncoated
7006-270332	UMDS 0095 S15 HMB	0.95mm	118°	2.30mm	3.00mm	1.50mm	30mm	Uncoated
7006-270333	UMDS 0100 S15 HMB	1.00mm	118°	2.50mm	3.20mm	1.50mm	30mm	Uncoated
7006-270334	UMDS 0105 S15 HMB	1.05mm	118°	2.60mm	3.50mm	1.50mm	30mm	Uncoated

Twist Drills - Solid Carbide with Reinforced Shank

UTILIS
u-drill



UMDS ...
Point relief: 4 facet, 118°

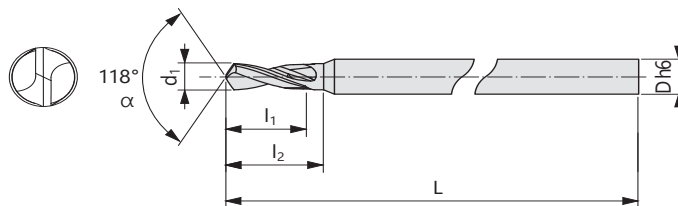

Item No.	Description	d ₁ Flute Ø	α Drill Point Angle	l ₁ Flute Length	l ₂ Neck Length	D h6 Shank Ø	L OAL	Coating
7006-270335	UMDS 0110 S15 HMB	1.10mm	118°	2.80mm	3.70mm	1.50mm	30mm	Uncoated
7006-270336	UMDS 0115 S15 HMB	1.15mm	118°	3.00mm	3.90mm	1.50mm	30mm	Uncoated
7006-270337	UMDS 0120 S15 HMB	1.20mm	118°	3.00mm	3.90mm	1.50mm	30mm	Uncoated
7006-270338	UMDS 0125 S15 HMB	1.25mm	118°	3.00mm	3.90mm	1.50mm	30mm	Uncoated
7006-270339	UMDS 0130 S15 HMB	1.30mm	118°	3.30mm	4.20mm	1.50mm	30mm	Uncoated
7006-270340	UMDS 0135 S15 HMB	1.35mm	118°	3.30mm	4.20mm	1.50mm	30mm	Uncoated
7006-270341	UMDS 0140 S15 HMB	1.40mm	118°	3.50mm	4.40mm	1.50mm	30mm	Uncoated
7006-270342	UMDS 0145 S15 HMB	1.45mm	118°	3.50mm	4.40mm	1.50mm	30mm	Uncoated
7006-270343	UMDS 0150 S20 HMB	1.50mm	118°	3.80mm	4.80mm	2.00mm	38mm	Uncoated
7006-270344	UMDS 0155 S20 HMB	1.55mm	118°	3.90mm	5.00mm	2.00mm	38mm	Uncoated
7006-270345	UMDS 0160 S20 HMB	1.60mm	118°	4.00mm	5.10mm	2.00mm	38mm	Uncoated
7006-270346	UMDS 0165 S20 HMB	1.65mm	118°	4.10mm	5.20mm	2.00mm	38mm	Uncoated
7006-270347	UMDS 0170 S20 HMB	1.70mm	118°	4.30mm	5.30mm	2.00mm	38mm	Uncoated
7006-270348	UMDS 0175 S20 HMB	1.75mm	118°	4.40mm	5.50mm	2.00mm	38mm	Uncoated
7006-270349	UMDS 0180 S20 HMB	1.80mm	118°	4.50mm	5.60mm	2.00mm	38mm	Uncoated
7006-270350	UMDS 0185 S20 HMB	1.85mm	118°	4.50mm	5.60mm	2.00mm	38mm	Uncoated
7006-270351	UMDS 0190 S20 HMB	1.90mm	118°	4.50mm	5.60mm	2.00mm	38mm	Uncoated
7006-270352	UMDS 0195 S20 HMB	1.95mm	118°	4.50mm	5.60mm	2.00mm	38mm	Uncoated
7006-270353	UMDS 0200 S30 HMB	2.00mm	118°	4.50mm	5.60mm	3.00mm	38mm	Uncoated
7006-270354	UMDS 0205 S30 HMB	2.05mm	118°	4.50mm	5.80mm	3.00mm	38mm	Uncoated
7006-270355	UMDS 0210 S30 HMB	2.10mm	118°	4.50mm	5.80mm	3.00mm	38mm	Uncoated
7006-270356	UMDS 0215 S30 HMB	2.15mm	118°	4.50mm	5.80mm	3.00mm	38mm	Uncoated
7006-270357	UMDS 0220 S30 HMB	2.20mm	118°	4.50mm	5.80mm	3.00mm	38mm	Uncoated
7006-270358	UMDS 0225 S30 HMB	2.25mm	118°	4.50mm	5.80mm	3.00mm	38mm	Uncoated
7006-270359	UMDS 0230 S30 HMB	2.30mm	118°	4.50mm	5.80mm	3.00mm	38mm	Uncoated
7006-270360	UMDS 0235 S30 HMB	2.35mm	118°	4.50mm	5.80mm	3.00mm	38mm	Uncoated
7006-270361	UMDS 0240 S30 HMB	2.40mm	118°	4.50mm	5.80mm	3.00mm	38mm	Uncoated
7006-270362	UMDS 0245 S30 HMB	2.45mm	118°	4.50mm	5.80mm	3.00mm	38mm	Uncoated
7006-270363	UMDS 0250 S30 HMB	2.50mm	118°	4.50mm	5.80mm	3.00mm	38mm	Uncoated
7006-270364	UMDS 0255 S30 HMB	2.55mm	118°	4.50mm	5.80mm	3.00mm	38mm	Uncoated
7006-270365	UMDS 0260 S30 HMB	2.60mm	118°	4.50mm	5.80mm	3.00mm	38mm	Uncoated
7006-270366	UMDS 0265 S30 HMB	2.65mm	118°	4.50mm	5.80mm	3.00mm	38mm	Uncoated
7006-270367	UMDS 0270 S30 HMB	2.70mm	118°	4.50mm	5.80mm	3.00mm	38mm	Uncoated
7006-270368	UMDS 0275 S30 HMB	2.75mm	118°	4.50mm	5.80mm	3.00mm	38mm	Uncoated
7006-270369	UMDS 0280 S30 HMB	2.80mm	118°	4.50mm	5.80mm	3.00mm	38mm	Uncoated
7006-270370	UMDS 0285 S30 HMB	2.85mm	118°	4.50mm	5.80mm	3.00mm	38mm	Uncoated
7006-270371	UMDS 0290 S30 HMB	2.90mm	118°	4.50mm	5.80mm	3.00mm	38mm	Uncoated
7006-270372	UMDS 0295 S30 HMB	2.95mm	118°	4.50mm	5.80mm	3.00mm	38mm	Uncoated
7006-270373	UMDS 0300 S30 HMB	3.00mm	118°	4.50mm	5.80mm	3.00mm	38mm	Uncoated

Twist Drills - Solid Carbide with Reinforced Shank

UTILIS
u-drill

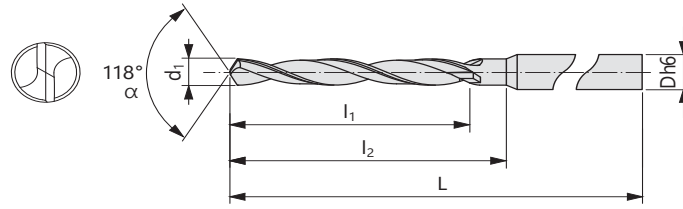

UMDL...

Point relief: 4 facet, 118°

Item No.	Description	d ₁ Flute Ø	α Drill Point Angle	I ₁ Flute Length	I ₂ Neck Length	D h6 Shank Ø	L OAL	Coating
7006-270374	UMDL 0010 S10 HMB	0.10mm	118°	0.60mm	0.80mm	1.00mm	30mm	Uncoated
7006-270375	UMDL 0015 S10 HMB	0.15mm	118°	0.80mm	1.00mm	1.00mm	30mm	Uncoated
7006-270376	UMDL 0020 S10 HMB	0.20mm	118°	1.00mm	1.30mm	1.00mm	30mm	Uncoated
7006-270377	UMDL 0025 S10 HMB	0.25mm	118°	1.00mm	1.30mm	1.00mm	30mm	Uncoated
7006-270378	UMDL 0030 S10 HMB	0.30mm	118°	1.50mm	1.80mm	1.00mm	30mm	Uncoated
7006-270379	UMDL 0035 S10 HMB	0.35mm	118°	1.50mm	1.80mm	1.00mm	30mm	Uncoated
7006-270380	UMDL 0040 S10 HMB	0.40mm	118°	2.00mm	2.40mm	1.00mm	30mm	Uncoated
7006-270381	UMDL 0045 S10 HMB	0.45mm	118°	3.50mm	4.00mm	1.00mm	30mm	Uncoated
7006-270382	UMDL 0050 S10 HMB	0.50mm	118°	4.00mm	4.90mm	1.00mm	30mm	Uncoated
7006-270383	UMDL 0055 S10 HMB	0.55mm	118°	4.50mm	5.40mm	1.00mm	30mm	Uncoated
7006-270384	UMDL 0060 S10 HMB	0.60mm	118°	4.50mm	5.40mm	1.00mm	30mm	Uncoated
7006-270385	UMDL 0065 S10 HMB	0.65mm	118°	5.00mm	6.00mm	1.00mm	30mm	Uncoated
7006-270386	UMDL 0070 S10 HMB	0.70mm	118°	5.60mm	6.70mm	1.00mm	30mm	Uncoated
7006-270387	UMDL 0075 S10 HMB	0.75mm	118°	5.60mm	6.70mm	1.00mm	30mm	Uncoated
7006-270388	UMDL 0080 S15 HMB	0.80mm	118°	6.50mm	7.60mm	1.50mm	30mm	Uncoated
7006-270389	UMDL 0085 S15 HMB	0.85mm	118°	6.50mm	7.60mm	1.50mm	30mm	Uncoated
7006-270390	UMDL 0090 S15 HMB	0.90mm	118°	7.00mm	8.20mm	1.50mm	30mm	Uncoated
7006-270391	UMDL 0095 S15 HMB	0.95mm	118°	7.00mm	8.20mm	1.50mm	30mm	Uncoated
7006-270392	UMDL 0100 S15 HMB	1.00mm	118°	9.00mm	10.40mm	1.50mm	30mm	Uncoated
7006-270393	UMDL 0105 S15 HMB	1.05mm	118°	9.00mm	10.40mm	1.50mm	30mm	Uncoated
7006-270394	UMDL 0110 S15 HMB	1.10mm	118°	9.00mm	10.4mm	1.50mm	30mm	Uncoated
7006-270395	UMDL 0115 S15 HMB	1.15mm	118°	9.00mm	10.40mm	1.50mm	30mm	Uncoated
7006-270396	UMDL 0120 S15 HMB	1.20mm	118°	10.00mm	11.50mm	1.50mm	30mm	Uncoated
7006-270397	UMDL 0125 S15 HMB	1.25mm	118°	10.00mm	11.50mm	1.50mm	30mm	Uncoated
7006-270398	UMDL 0130 S15 HMB	1.30mm	118°	10.00mm	11.50mm	1.50mm	30mm	Uncoated
7006-270399	UMDL 0135 S15 HMB	1.35mm	118°	11.50mm	13.10mm	1.50mm	30mm	Uncoated
7006-270400	UMDL 0140 S15 HMB	1.40mm	118°	11.50mm	13.10mm	1.50mm	30mm	Uncoated
7006-270401	UMDL 0145 S15 HMB	1.45mm	118°	11.50mm	13.10mm	1.50mm	30mm	Uncoated
7006-270402	UMDL 0150 S20 HMB	1.50mm	118°	12.00mm	13.60mm	2.00mm	38mm	Uncoated
7006-270403	UMDL 0155 S20 HMB	1.55mm	118°	12.00mm	13.80mm	2.00mm	38mm	Uncoated
7006-270404	UMDL 0160 S20 HMB	1.60mm	118°	12.00mm	13.80mm	2.00mm	38mm	Uncoated
7006-270405	UMDL 0165 S20 HMB	1.65mm	118°	12.00mm	13.80mm	2.00mm	38mm	Uncoated
7006-270406	UMDL 0170 S20 HMB	1.70mm	118°	12.00mm	13.80mm	2.00mm	38mm	Uncoated
7006-270407	UMDL 0175 S20 HMB	1.75mm	118°	12.00mm	13.80mm	2.00mm	38mm	Uncoated
7006-270408	UMDL 0180 S20 HMB	1.80mm	118°	12.00mm	13.80mm	2.00mm	38mm	Uncoated
7006-270409	UMDL 0185 S20 HMB	1.85mm	118°	12.00mm	13.80mm	2.00mm	38mm	Uncoated
7006-270410	UMDL 0190 S20 HMB	1.90mm	118°	12.00mm	13.80mm	2.00mm	38mm	Uncoated
7006-270411	UMDL 0195 S20 HMB	1.95mm	118°	12.00mm	13.80mm	2.00mm	38mm	Uncoated
7006-270412	UMDL 0200 S30 HMB	2.00mm	118°	12.00mm	13.80mm	3.00mm	38mm	Uncoated
7006-270413	UMDL 0205 S30 HMB	2.05mm	118°	12.00mm	14.00mm	3.00mm	38mm	Uncoated
7006-270414	UMDL 0210 S30 HMB	2.10mm	118°	12.00mm	14.00mm	3.00mm	38mm	Uncoated
7006-270415	UMDL 0215 S30 HMB	2.15mm	118°	12.00mm	14.00mm	3.00mm	38mm	Uncoated
7006-270416	UMDL 0220 S30 HMB	2.20mm	118°	12.00mm	14.00mm	3.00mm	38mm	Uncoated
7006-270417	UMDL 0225 S30 HMB	2.25mm	118°	12.00mm	14.00mm	3.00mm	38mm	Uncoated
7006-270418	UMDL 0230 S30 HMB	2.30mm	118°	12.00mm	14.00mm	3.00mm	38mm	Uncoated
7006-270419	UMDL 0235 S30 HMB	2.35mm	118°	12.00mm	14.00mm	3.00mm	38mm	Uncoated
7006-270420	UMDL 0240 S30 HMB	2.40mm	118°	12.00mm	14.00mm	3.00mm	38mm	Uncoated
7006-270421	UMDL 0245 S30 HMB	2.45mm	118°	12.00mm	14.00mm	3.00mm	38mm	Uncoated
7006-270422	UMDL 0250 S30 HMB	2.50mm	118°	12.00mm	14.00mm	3.00mm	38mm	Uncoated
7006-270423	UMDL 0255 S30 HMB	2.55mm	118°	12.00mm	14.00mm	3.00mm	38mm	Uncoated

Twist Drills - Solid Carbide with Reinforced Shank

UTILIS
u-drill

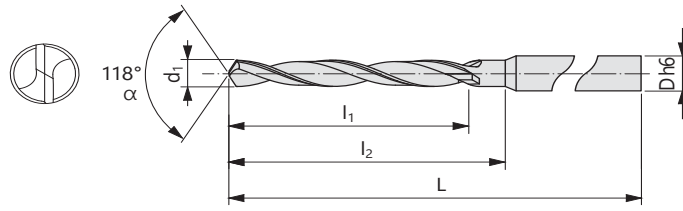

UMDL...
Point relief: 4 facet, 118°

Item No.	Description	d ₁ Flute Ø	α Drill Point Angle	L ₁ Flute Length	L ₂ Neck Length	D h6 Shank Ø	L OAL	Coating
7006-270424	UMDL 0260 S30 HMB	2.60mm	118°	12.00mm	14.00mm	3.00mm	38mm	Uncoated
7006-270425	UMDL 0265 S30 HMB	2.65mm	118°	12.00mm	14.00mm	3.00mm	38mm	Uncoated
7006-270426	UMDL 0270 S30 HMB	2.70mm	118°	12.00mm	14.00mm	3.00mm	38mm	Uncoated
7006-270427	UMDL 0275 S30 HMB	2.75mm	118°	12.00mm	14.00mm	3.00mm	38mm	Uncoated
7006-270428	UMDL 0280 S30 HMB	2.80mm	118°	12.00mm	14.00mm	3.00mm	38mm	Uncoated
7006-270429	UMDL 0285 S30 HMB	2.85mm	118°	12.00mm	14.00mm	3.00mm	38mm	Uncoated
7006-270430	UMDL 0290 S30 HMB	2.90mm	118°	12.00mm	14.00mm	3.00mm	38mm	Uncoated
7006-270431	UMDL 0295 S30 HMB	2.95mm	118°	12.00mm	14.00mm	3.00mm	38mm	Uncoated
7006-270432	UMDL 0300 S30 HMB	3.00mm	118°	12.00mm	14.00mm	3.00mm	38mm	Uncoated

For Ø < 2.0 mm drills, intermediate dimensions are available on request.

Solid carbide micro end mill

With centre cut

UTILIS
u-mill

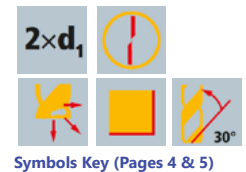
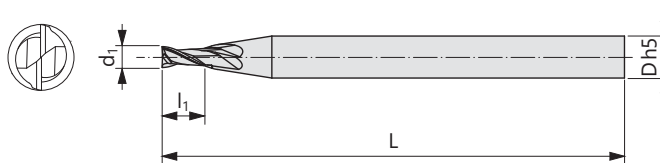

UMM 2...x 02...

Item No.	Description	d ₁ Flute Ø	L ₁ Flute Length	D h5 Shank Ø	Z Flutes	L OAL	Coating
7006-270000	UMM 20020 x 02 S30 HMB	0.20mm	0.40mm	3.00mm	2	38mm	Uncoated
7006-270001	UMM 20020 x 02 S30 HMP700	0.20mm	0.40mm	3.00mm	2	38mm	HMP700
7006-270004	UMM 20025 x 02 S30 HMB	0.25mm	0.50mm	3.00mm	2	38mm	Uncoated
7006-270005	UMM 20025 x 02 S30 HMP700	0.25mm	0.50mm	3.00mm	2	38mm	HMP700
7006-270008	UMM 20030 x 02 S30 HMB	0.30mm	0.60mm	3.00mm	2	38mm	Uncoated
7006-270009	UMM 20030 x 02 S30 HMP700	0.30mm	0.60mm	3.00mm	2	38mm	HMP700
7006-270014	UMM 20040 x 02 S30 HMB	0.40mm	0.80mm	3.00mm	2	38mm	Uncoated
7006-270015	UMM 20040 x 02 S30 HMP700	0.40mm	0.80mm	3.00mm	2	38mm	HMP700
7006-270020	UMM 20050 x 02 S30 HMB	0.50mm	1.00mm	3.00mm	2	38mm	Uncoated
7006-270021	UMM 20050 x 02 S30 HMP700	0.50mm	1.00mm	3.00mm	2	38mm	HMP700
7006-270026	UMM 20060 x 02 S30 HMB	0.60mm	1.20mm	3.00mm	2	38mm	Uncoated
7006-270027	UMM 20060 x 02 S30 HMP700	0.60mm	1.20mm	3.00mm	2	38mm	HMP700
7006-270032	UMM 20070 x 02 S30 HMB	0.70mm	1.40mm	3.00mm	2	38mm	Uncoated
7006-270033	UMM 20070 x 02 S30 HMP700	0.70mm	1.40mm	3.00mm	2	38mm	HMP700
7006-270038	UMM 20080 x 02 S30 HMB	0.80mm	1.60mm	3.00mm	2	38mm	Uncoated
7006-270039	UMM 20080 x 02 S30 HMP700	0.80mm	1.60mm	3.00mm	2	38mm	HMP700
7006-270044	UMM 20090 x 02 S30 HMB	0.90mm	1.80mm	3.00mm	2	38mm	Uncoated
7006-270045	UMM 20090 x 02 S30 HMP700	0.90mm	1.80mm	3.00mm	2	38mm	HMP700
7006-270050	UMM 20100 x 02 S30 HMB	1.00mm	2.00mm	3.00mm	2	38mm	Uncoated
7006-270051	UMM 20100 x 02 S30 HMP700	1.00mm	2.00mm	3.00mm	2	38mm	HMP700
7006-270056	UMM 20120 x 02 S30 HMB	1.20mm	2.40mm	3.00mm	2	38mm	Uncoated
7006-270057	UMM 20120 x 02 S30 HMP700	1.20mm	2.40mm	3.00mm	2	38mm	HMP700
7006-270062	UMM 20150 x 02 S30 HMB	1.50mm	3.00mm	3.00mm	2	38mm	Uncoated
7006-270063	UMM 20150 x 02 S30 HMP700	1.50mm	3.00mm	3.00mm	2	38mm	HMP700

Solid carbide micro end mill

With centre cut

UTILIS
u-mill

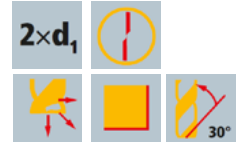
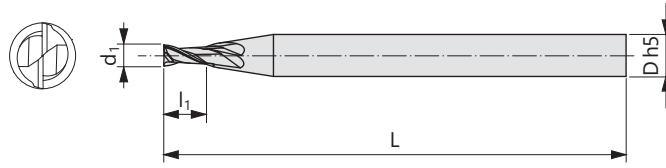

Symbols Key (Pages 4 & 5)

UMM 2...x 02...

Item No.	Description	d1 Flute Ø	l1 Flute Length	D h5 Shank Ø	Z Flutes	L OAL	Coating
7006-270070	UMM 2020 x 02 S30 HMB	2.00mm	4.00mm	3.00mm	2	38mm	Uncoated
7006-270071	UMM 2020 x 02 S30 HMP700	2.00mm	4.00mm	3.00mm	2	38mm	HMP700
7006-270076	UMM 20250 x 02 S30 HMB	2.50mm	5.00mm	3.00mm	2	38mm	Uncoated
7006-270077	UMM 20250 x 02 S30 HMP700	2.50mm	5.00mm	3.00mm	2	38mm	HMP700
7006-270084	UMM 20300 x 02 S30 HMB	3.00mm	6.00mm	3.00mm	2	38mm	Uncoated
7006-270085	UMM 20300 x 02 S30 HMP700	3.00mm	6.00mm	3.00mm	2	38mm	HMP700

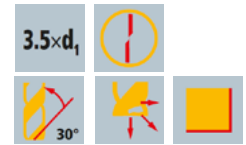
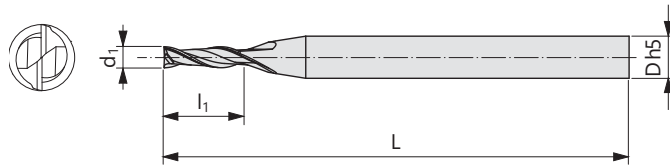

Symbols Key (Pages 4 & 5)

UMM 2...x 035...

Item No.	Description	d1 Flute Ø	l1 Flute Length	D h5 Shank Ø	Z Flutes	L OAL	Coating
7006-270002	UMM 20020 x 035 S30 HMB	0.20mm	0.70mm	3.00mm	2	38mm	Uncoated
7006-270003	UMM 20020 x 035 S30 HMP700	0.20mm	0.70mm	3.00mm	2	38mm	HMP700
7006-270004	UMM 20025 x 035 S30 HMB	0.25mm	0.90mm	3.00mm	2	38mm	Uncoated
7006-270007	UMM 20025 x 035 S30 HMP700	0.25mm	0.90mm	3.00mm	2	38mm	HMP700
7006-270010	UMM 20030 x 035 S30 HMB	0.30mm	1.10mm	3.00mm	2	38mm	Uncoated
7006-270011	UMM 20030 x 035 S30 HMP700	0.30mm	1.10mm	3.00mm	2	38mm	HMP700
7006-270016	UMM 20040 x 035 S30 HMB	0.40mm	1.40mm	3.00mm	2	38mm	Uncoated
7006-270017	UMM 20040 x 035 S30 HMP700	0.40mm	1.40mm	3.00mm	2	38mm	HMP700
7006-270022	UMM 20050 x 035 S30 HMB	0.50mm	1.80mm	3.00mm	2	38mm	Uncoated
7006-270023	UMM 20050 x 035 S30 HMP700	0.50mm	1.80mm	3.00mm	2	38mm	HMP700
7006-270028	UMM 20060 x 035 S30 HMB	0.60mm	2.10mm	3.00mm	2	38mm	Uncoated
7006-270029	UMM 20060 x 035 S30 HMP700	0.60mm	2.10mm	3.00mm	2	38mm	HMP700
7006-270034	UMM 20070 x 035 S30 HMB	0.70mm	2.50mm	3.00mm	2	38mm	Uncoated
7006-270035	UMM 20070 x 035 S30 HMP700	0.70mm	2.50mm	3.00mm	2	38mm	HMP700
7006-270040	UMM 20080 x 035 S30 HMB	0.80mm	2.80mm	3.00mm	2	38mm	Uncoated
7006-270041	UMM 20080 x 035 S30 HMP700	0.80mm	2.80mm	3.00mm	2	38mm	HMP700
7006-270046	UMM 20090 x 035 S30 HMB	0.90mm	3.20mm	3.00mm	2	38mm	Uncoated
7006-270047	UMM 20090 x 035 S30 HMP700	0.90mm	3.20mm	3.00mm	2	38mm	HMP700
7006-270052	UMM 20100 x 035 S30 HMB	1.00mm	3.50mm	3.00mm	2	38mm	Uncoated
7006-270053	UMM 20100 x 035 S30 HMP700	1.00mm	3.50mm	3.00mm	2	38mm	HMP700
7006-270058	UMM 20120 x 035 S30 HMB	1.20mm	4.20mm	3.00mm	2	38mm	Uncoated
7006-270059	UMM 20120 x 035 S30 HMP700	1.20mm	4.20mm	3.00mm	2	38mm	HMP700
7006-270064	UMM 20150 x 035 S30 HMB	1.50mm	5.20mm	3.00mm	2	38mm	Uncoated
7006-270065	UMM 20150 x 035 S30 HMP700	1.50mm	5.20mm	3.00mm	2	38mm	HMP700
7006-270072	UMM 20200 x 035 S30 HMB	2.00mm	7.00mm	3.00mm	2	38mm	Uncoated
7006-270073	UMM 20200 x 035 S30 HMP700	2.00mm	7.00mm	3.00mm	2	38mm	HMP700
7006-270078	UMM 20250 x 035 S30 HMB	2.50mm	8.80mm	3.00mm	2	38mm	Uncoated
7006-270079	UMM 20250 x 035 S30 HMP700	2.50mm	8.80mm	3.00mm	2	38mm	HMP700
7006-270080	UMM 20300 x 035 S30 HMB	3.00mm	10.50mm	3.00mm	2	38mm	Uncoated
7006-270081	UMM 20300 x 035 S30 HMP700	3.00mm	10.50mm	3.00mm	2	38mm	HMP700

Solid carbide micro end mill

With centre cut

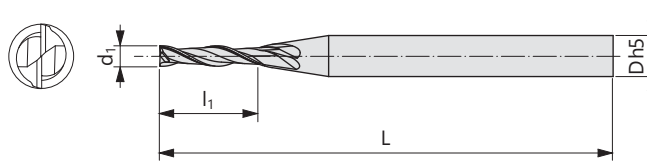

UTILIS
u-mill

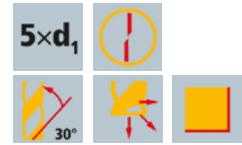

Symbols Key (Pages 4 & 5)

UMM 2...x 05...

Item No.	Description	d1 Flute Ø	I ₁ Flute Length	D h5 Shank Ø	Z Flutes	L OAL	Coating
7006-270012	UMM 20030 x 05 S30 HMB	0.30mm	1.50mm	3.00mm	2	38mm	Uncoated
7006-270013	UMM 20030 x 05 S30 HMP700	0.30mm	1.50mm	3.00mm	2	38mm	HMP700
7006-270018	UMM 20040 x 05 S30 HMB	0.40mm	2.00mm	3.00mm	2	38mm	Uncoated
7006-270019	UMM 20040 x 05 S30 HMP700	0.40mm	2.00mm	3.00mm	2	38mm	HMP700
7006-270024	UMM 20050 x 05 S30 HMB	0.50mm	2.50mm	3.00mm	2	38mm	Uncoated
7006-270025	UMM 20050 x 05 S30 HMP700	0.50mm	2.50mm	3.00mm	2	38mm	HMP700
7006-270030	UMM 20060 x 05 S30 HMB	0.60mm	3.00mm	3.00mm	2	38mm	Uncoated
7006-270031	UMM 20060 x 05 S30 HMP700	0.60mm	3.00mm	3.00mm	2	38mm	HMP700
7006-270036	UMM 20070 x 05 S30 HMB	0.70mm	3.50mm	3.00mm	2	38mm	Uncoated
7006-270037	UMM 20070 x 05 S30 HMP700	0.70mm	3.50mm	3.00mm	2	38mm	HMP700
7006-270042	UMM 20080 x 05 S30 HMB	0.80mm	4.00mm	3.00mm	2	38mm	Uncoated
7006-270043	UMM 20080 x 05 S30 HMP700	0.80mm	4.00mm	3.00mm	2	38mm	HMP700
7006-270048	UMM 20090 x 05 S30 HMB	0.90mm	4.50mm	3.00mm	2	38mm	Uncoated
7006-270049	UMM 20090 x 05 S30 HMP700	0.90mm	4.50mm	3.00mm	2	38mm	HMP700
7006-270054	UMM 20100 x 05 S30 HMB	1.00mm	5.00mm	3.00mm	2	38mm	Uncoated
7006-270055	UMM 20100 x 05 S30 HMP700	1.00mm	5.00mm	3.00mm	2	38mm	HMP700
7006-270060	UMM 20120 x 05 S30 HMB	1.20mm	6.00mm	3.00mm	2	38mm	Uncoated
7006-270061	UMM 20120 x 05 S30 HMP700	1.20mm	6.00mm	3.00mm	2	38mm	HMP700
7006-270066	UMM 20150 x 05 S30 HMB	1.50mm	7.50mm	3.00mm	2	38mm	Uncoated
7006-270067	UMM 20150 x 05 S30 HMP700	1.50mm	7.50mm	3.00mm	2	38mm	HMP700
7006-270068	UMM 20200 x 05 S30 HMB	2.00mm	10.00mm	3.00mm	2	38mm	Uncoated
7006-270069	UMM 20200 x 05 S30 HMP700	2.00mm	10.00mm	3.00mm	2	38mm	HMP700
7006-270074	UMM 20250 x 05 S30 HMB	2.50mm	12.50mm	3.00mm	2	38mm	Uncoated
7006-270075	UMM 20250 x 05 S30 HMP700	2.50mm	12.50mm	3.00mm	2	38mm	HMP700
7006-270082	UMM 20300 x 05 S30 HMB	3.00mm	15.00mm	3.00mm	2	38mm	Uncoated
7006-270083	UMM 20300 x 05 S30 HMP700	3.00mm	15.00mm	3.00mm	2	38mm	HMP700

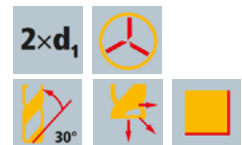
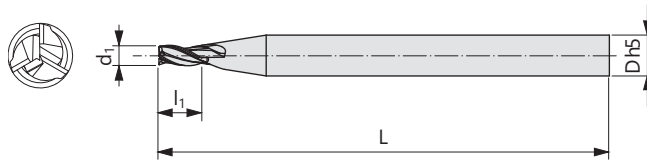

Symbols Key (Pages 4 & 5)

UMM 3...x 02...

Item No.	Description	d1 Flute Ø	I ₁ Flute Length	D h5 Shank Ø	Z Flutes	L OAL	Coating
7006-270086	UMM 30030 x 02 S30 HMB	0.30mm	0.60mm	3.00mm	3	38mm	Uncoated
7006-270087	UMM 30030 x 02 S30 HMP700	0.30mm	0.60mm	3.00mm	3	38mm	HMP700
7006-270092	UMM 30040 x 02 S30 HMB	0.40mm	0.80mm	3.00mm	3	38mm	Uncoated
7006-270093	UMM 30040 x 02 S30 HMP700	0.40mm	0.80mm	3.00mm	3	38mm	HMP700
7006-270098	UMM 30050 x 02 S30 HMB	0.50mm	1.00mm	3.00mm	3	38mm	Uncoated
7006-270099	UMM 30050 x 02 S30 HMP700	0.50mm	1.00mm	3.00mm	3	38mm	HMP700
7006-270104	UMM 30060 x 02 S30 HMB	0.60mm	1.20mm	3.00mm	3	38mm	Uncoated
7006-270105	UMM 30060 x 02 S30 HMP700	0.60mm	1.20mm	3.00mm	3	38mm	HMP700
7006-270110	UMM 30070 x 02 S30 HMB	0.70mm	1.40mm	3.00mm	3	38mm	Uncoated
7006-270111	UMM 30070 x 02 S30 HMP700	0.70mm	1.40mm	3.00mm	3	38mm	HMP700
7006-270115	UMM 30080 x 02 S30 HMB	0.80mm	1.60mm	3.00mm	3	38mm	Uncoated
7006-270116	UMM 30080 x 02 S30 HMP700	0.80mm	1.60mm	3.00mm	3	38mm	HMP700

Solid carbide micro end mill

With centre cut

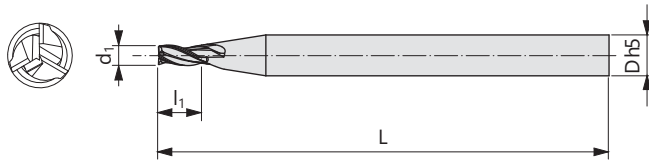

UTILIS
u-mill



Symbols Key (Pages 4 & 5)

UMM 3...x 02...

Item No.	Description	d1 Flute Ø	l1 Flute Length	D h5 Shank Ø	Z Flutes	L OAL	Coating
7006-270121	UMM 30090 x 02 S30 HMB	0.90mm	1.80mm	3.00mm	3	38mm	Uncoated
7006-270122	UMM 30090 x 02 S30 HMP700	0.90mm	1.80mm	3.00mm	3	38mm	HMP700
7006-270127	UMM 30100 x 02 S30 HMB	1.00mm	2.00mm	3.00mm	3	38mm	Uncoated
7006-270128	UMM 30100 x 02 S30 HMP700	1.00mm	2.00mm	3.00mm	3	38mm	HMP700
7006-270133	UMM 30120 x 02 S30 HMB	1.20mm	2.40mm	3.00mm	3	38mm	Uncoated
7006-270134	UMM 30120 x 02 S30 HMP700	1.20mm	2.40mm	3.00mm	3	38mm	HMP700
7006-270139	UMM 30150 x 02 S30 HMB	1.50mm	3.00mm	3.00mm	3	38mm	Uncoated
7006-270140	UMM 30150 x 02 S30 HMP700	1.50mm	3.00mm	3.00mm	3	38mm	HMP700
7006-270147	UMM 30200 x 02 S30 HMB	2.00mm	4.00mm	3.00mm	3	38mm	Uncoated
7006-270148	UMM 30200 x 02 S30 HMP700	2.00mm	4.00mm	3.00mm	3	38mm	HMP700
7006-270153	UMM 30250 x 02 S30 HMB	2.50mm	5.00mm	3.00mm	3	38mm	Uncoated
7006-270154	UMM 30250 x 02 S30 HMP700	2.50mm	5.00mm	3.00mm	3	38mm	HMP700
7006-270161	UMM 30300 x 02 S30 HMB	3.00mm	6.00mm	3.00mm	3	38mm	Uncoated
7006-270162	UMM 30300 x 02 S30 HMP700	3.00mm	6.00mm	3.00mm	3	38mm	HMP700

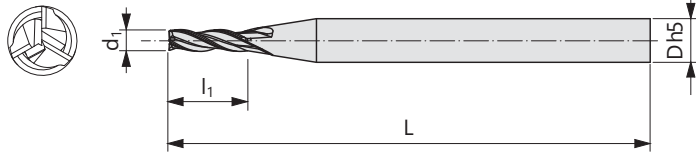

Symbols Key (Pages 4 & 5)

UMM 3...x 035...

Item No.	Description	d1 Flute Ø	l1 Flute Length	D h5 Shank Ø	Z Flutes	L OAL	Coating
7006-270088	UMM 30030 x 035 S30 HMB	0.30mm	1.10mm	3.00mm	3	38mm	Uncoated
7006-270089	UMM 30030 x 035 S30 HMP700	0.30mm	1.10mm	3.00mm	3	38mm	HMP700
7006-270094	UMM 30040 x 035 S30 HMB	0.40mm	1.40mm	3.00mm	3	38mm	Uncoated
7006-270095	UMM 30040 x 035 S30 HMP700	0.40mm	1.40mm	3.00mm	3	38mm	HMP700
7006-270100	UMM 30050 x 035 S30 HMB	0.50mm	1.80mm	3.00mm	3	38mm	Uncoated
7006-270101	UMM 30050 x 035 S30 HMP700	0.50mm	1.80mm	3.00mm	3	38mm	HMP700
7006-270106	UMM 30060 x 035 S30 HMB	0.60mm	2.10mm	3.00mm	3	38mm	Uncoated
7006-270107	UMM 30060 x 035 S30 HMP700	0.60mm	2.10mm	3.00mm	3	38mm	HMP700
7006-270112	UMM 30070 x 035 S30 HMB	0.70mm	2.50mm	3.00mm	3	38mm	Uncoated
7006-270113	UMM 30070 x 035 S30 HMP700	0.70mm	2.50mm	3.00mm	3	38mm	HMP700
7006-270117	UMM 30080 x 035 S30 HMB	0.80mm	2.80mm	3.00mm	3	38mm	Uncoated
7006-270118	UMM 30080 x 035 S30 HMP700	0.80mm	2.80mm	3.00mm	3	38mm	HMP700
7006-270123	UMM 30090 x 035 S30 HMB	0.90mm	3.20mm	3.00mm	3	38mm	Uncoated
7006-270124	UMM 30090 x 035 S30 HMP700	0.90mm	3.20mm	3.00mm	3	38mm	HMP700
7006-270129	UMM 30100 x 035 S30 HMB	1.00mm	3.50mm	3.00mm	3	38mm	Uncoated
7006-270130	UMM 30100 x 035 S30 HMP700	1.00mm	3.50mm	3.00mm	3	38mm	HMP700
7006-270135	UMM 30120 x 035 S30 HMB	1.20mm	4.20mm	3.00mm	3	38mm	Uncoated
7006-270136	UMM 30120 x 035 S30 HMP700	1.20mm	4.20mm	3.00mm	3	38mm	HMP700
7006-270141	UMM 30150 x 035 S30 HMB	1.50mm	5.20mm	3.00mm	3	38mm	Uncoated
7006-270142	UMM 30150 x 035 S30 HMP700	1.50mm	5.20mm	3.00mm	3	38mm	HMP700
7006-270149	UMM 30200 x 035 S30 HMB	2.00mm	7.00mm	3.00mm	3	38mm	Uncoated
7006-270150	UMM 30200 x 035 S30 HMP700	2.00mm	7.00mm	3.00mm	3	38mm	HMP700
7006-270155	UMM 30250 x 035 S30 HMB	2.50mm	8.80mm	3.00mm	3	38mm	Uncoated
7006-270156	UMM 30250 x 035 S30 HMP700	2.50mm	8.80mm	3.00mm	3	38mm	HMP700
7006-270157	UMM 30300 x 035 S30 HMB	3.00mm	10.50mm	3.00mm	3	38mm	Uncoated
7006-270158	UMM 30300 x 035 S30 HMP700	3.00mm	10.50mm	3.00mm	3	38mm	HMP700

Solid carbide micro end mill

With centre cut

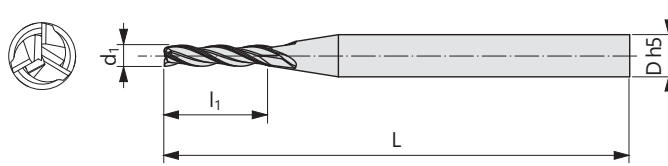

UTILIS
u-mill



UMM 3...x 05...

Item No.	Description	d1 Flute Ø 0/-0.015	l1 Flute Length	D h5 Shank Ø	Z Flutes	L OAL	Coating
7006-270090	UMM 30030 x 05 S30 HMB	0.30mm	1.50mm	3.00mm	3	38mm	Uncoated
7006-270091	UMM 30030 x 05 S30 HMP700	0.30mm	1.50mm	3.00mm	3	38mm	HMP700
7006-270096	UMM 30040 x 05 S30 HMB	0.40mm	2.00mm	3.00mm	3	38mm	Uncoated
7006-270097	UMM 30040 x 05 S30 HMP700	0.40mm	2.00mm	3.00mm	3	38mm	HMP700
7006-270102	UMM 30050 x 05 S30 HMB	0.50mm	2.50mm	3.00mm	3	38mm	Uncoated
7006-270103	UMM 30050 x 05 S30 HMP700	0.50mm	2.50mm	3.00mm	3	38mm	HMP700
7006-270108	UMM 30060 x 05 S30 HMB	0.60mm	3.00mm	3.00mm	3	38mm	Uncoated
7006-270109	UMM 30060 x 05 S30 HMP700	0.60mm	3.00mm	3.00mm	3	38mm	HMP700
7006-270114	UMM 30070 x 05 S30 HMB	0.70mm	3.50mm	3.00mm	3	38mm	Uncoated
7006-270885	UMM 30070 x 05 S30 HMP700	0.70mm	3.50mm	3.00mm	3	38mm	HMP700
7006-270119	UMM 30080 x 05 S30 HMB	0.80mm	4.00mm	3.00mm	3	38mm	Uncoated
7006-270120	UMM 30080 x 05 S30 HMP700	0.80mm	4.00mm	3.00mm	3	38mm	HMP700
7006-270125	UMM 30090 x 05 S30 HMB	0.90mm	4.50mm	3.00mm	3	38mm	Uncoated
7006-270126	UMM 30090 x 05 S30 HMP700	0.90mm	4.50mm	3.00mm	3	38mm	HMP700
7006-270131	UMM 30100 x 05 S30 HMB	1.00mm	5.00mm	3.00mm	3	38mm	Uncoated
7006-270132	UMM 30100 x 05 S30 HMP700	1.00mm	5.00mm	3.00mm	3	38mm	HMP700
7006-270137	UMM 30120 x 05 S30 HMB	1.20mm	6.00mm	3.00mm	3	38mm	Uncoated
7006-270138	UMM 30120 x 05 S30 HMP700	1.20mm	6.00mm	3.00mm	3	38mm	HMP700
7006-270143	UMM 30150 x 05 S30 HMB	1.50mm	7.50mm	3.00mm	3	38mm	Uncoated
7006-270144	UMM 30150 x 05 S30 HMP700	1.50mm	7.50mm	3.00mm	3	38mm	HMP700
7006-270145	UMM 30200 x 05 S30 HMB	2.00mm	10.00mm	3.00mm	3	38mm	Uncoated
7006-270146	UMM 30200 x 05 S30 HMP700	2.00mm	10.00mm	3.00mm	3	38mm	HMP700
7006-270151	UMM 30250 x 05 S30 HMB	2.50mm	12.50mm	3.00mm	3	38mm	Uncoated
7006-270152	UMM 30250 x 05 S30 HMP700	2.50mm	12.50mm	3.00mm	3	38mm	HMP700
7006-270159	UMM 30300 x 05 S30 HMB	3.00mm	15.00mm	3.00mm	3	38mm	Uncoated
7006-270160	UMM 30300 x 05 S30 HMP700	3.00mm	15.00mm	3.00mm	3	38mm	HMP700

Ball nose end mill solid carbide

With centre cut and without tooth pitch

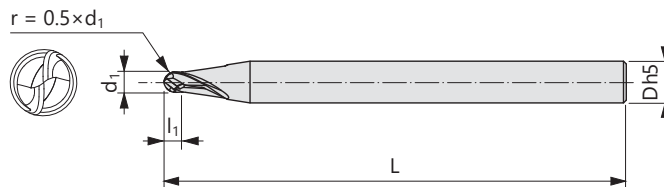

UTILIS
u-mill

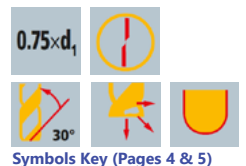

UMMB 2...x 0075...

Item No.	Description	d1 Flute Ø	l1 Flute Length	D h5 Shank Ø	Z Flutes	L OAL	Coating
7006-270163	UMMB 20030 x 0075 S30 HMB	0.30mm	0.23mm	3.00mm	2	38mm	Uncoated
7006-270164	UMMB 20030 x 0075 S30 HMP700	0.30mm	0.23mm	3.00mm	2	38mm	HMP700
7006-270167	UMMB 20040 x 0075 S30 HMB	0.40mm	0.30mm	3.00mm	2	38mm	Uncoated
7006-270168	UMMB 20040 x 0075 S30 HMP700	0.40mm	0.30mm	3.00mm	2	38mm	HMP700
7006-270171	UMMB 20050 x 0075 S30 HMB	0.50mm	0.38mm	3.00mm	2	38mm	Uncoated
7006-270172	UMMB 20050 x 0075 S30 HMP700	0.50mm	0.38mm	3.00mm	2	38mm	HMP700
7006-270175	UMMB 20060 x 0075 S30 HMB	0.60mm	0.45mm	3.00mm	2	38mm	Uncoated
7006-270176	UMMB 20060 x 0075 S30 HMP700	0.60mm	0.45mm	3.00mm	2	38mm	HMP700
7006-270179	UMMB 20070 x 0075 S30 HMB	0.70mm	0.55mm	3.00mm	2	38mm	Uncoated
7006-270180	UMMB 20070 x 0075 S30 HMP700	0.70mm	0.55mm	3.00mm	2	38mm	HMP700

Ball nose end mill solid carbide

With centre cut and without tooth pitch

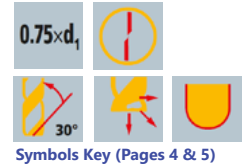
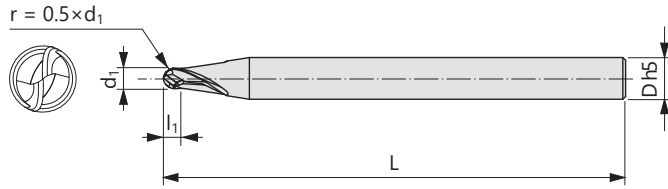

UMMB 2...x 0075...

Item No.	Description	d ₁ Flute Ø	l ₁ Flute Length	D h5 Shank Ø	Z Flutes	L OAL	Coating
7006-270183	UMMB 20080 x 0075 S30 HMB	0.80mm	0.60mm	3.00mm	2	38mm	Uncoated
7006-270184	UMMB 20080 x 0075 S30 HMP700	0.80mm	0.60mm	3.00mm	2	38mm	HMP700
7006-270187	UMMB 20090 x 0075 S30 HMB	0.90mm	0.68mm	3.00mm	2	38mm	Uncoated
7006-270188	UMMB 20090 x 0075 S30 HMP700	0.90mm	0.68mm	3.00mm	2	38mm	HMP700
7006-270191	UMMB 20100 x 0075 S30 HMB	1.00mm	0.75mm	3.00mm	2	38mm	Uncoated
7006-270192	UMMB 20100 x 0075 S30 HMP700	1.00mm	0.75mm	3.00mm	2	38mm	HMP700
7006-270195	UMMB 20150 x 0075 S30 HMB	1.50mm	1.13mm	3.00mm	2	38mm	Uncoated
7006-270196	UMMB 20150 x 0075 S30 HMP700	1.50mm	1.13mm	3.00mm	2	38mm	HMP700
7006-270199	UMMB 20200 x 0075 S30 HMB	2.00mm	1.50mm	3.00mm	2	38mm	Uncoated
7006-270200	UMMB 20200 x 0075 S30 HMP700	2.00mm	1.50mm	3.00mm	2	38mm	HMP700
7006-270203	UMMB 20250 x 0075 S30 HMB	2.50mm	1.88mm	3.00mm	2	38mm	Uncoated
7006-270204	UMMB 20250 x 0075 S30 HMP700	2.50mm	1.88mm	3.00mm	2	38mm	HMP700
7006-270207	UMMB 20300 x 0075 S30 HMB	3.00mm	2.25mm	3.00mm	2	38mm	Uncoated
7006-270208	UMMB 20300 x 0075 S30 HMP700	3.00mm	2.25mm	3.00mm	2	38mm	HMP700

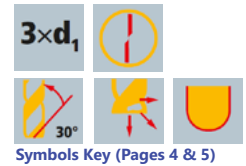
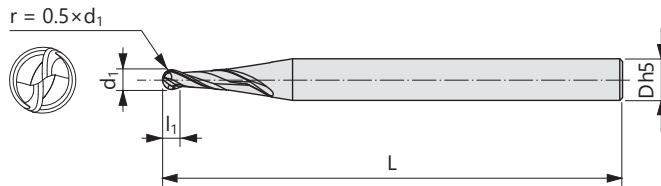

UMMB 2...x 03...

Item No.	Description	d ₁ Flute Ø	l ₁ Flute Length	D h5 Shank Ø	Z Flutes	L OAL	Coating
7006-270165	UMMB 20030 x 03 S30 HMB	0.30mm	0.90mm	3.00mm	2	38mm	Uncoated
7006-270166	UMMB 20030 x 03 S30 HMP700	0.30mm	0.90mm	3.00mm	2	38mm	HMP700
7006-270169	UMMB 20040 x 03 S30 HMB	0.40mm	1.20mm	3.00mm	2	38mm	Uncoated
7006-270170	UMMB 20040 x 03 S30 HMP700	0.40mm	1.20mm	3.00mm	2	38mm	HMP700
7006-270173	UMMB 20050 x 03 S30 HMB	0.50mm	1.50mm	3.00mm	2	38mm	Uncoated
7006-270174	UMMB 20050 x 03 S30 HMP700	0.50mm	1.50mm	3.00mm	2	38mm	HMP700
7006-270177	UMMB 20060 x 03 S30 HMB	0.60mm	1.80mm	3.00mm	2	38mm	Uncoated
7006-270178	UMMB 20060 x 03 S30 HMP700	0.60mm	1.80mm	3.00mm	2	38mm	HMP700
7006-270181	UMMB 20070 x 03 S30 HMB	0.70mm	2.10mm	3.00mm	2	38mm	Uncoated
7006-270182	UMMB 20070 x 03 S30 HMP700	0.70mm	2.10mm	3.00mm	2	38mm	HMP700
7006-270185	UMMB 20080 x 03 S30 HMB	0.80mm	2.40mm	3.00mm	2	38mm	Uncoated
7006-270186	UMMB 20080 x 03 S30 HMP700	0.80mm	2.40mm	3.00mm	2	38mm	HMP700
7006-270189	UMMB 20090 x 03 S30 HMB	0.90mm	2.70mm	3.00mm	2	38mm	Uncoated

Ball nose end mill solid carbide

With centre cut and without tooth pitch

UTILIS
u-mill

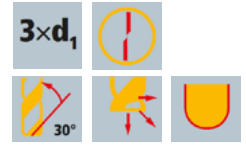
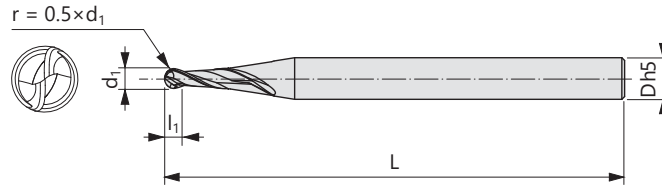

Symbols Key (Pages 4 & 5)

UMMB 2...x 03...

Item No.	Description	d ₁ Flute Ø	l ₁ Flute Length	D h5 Shank Ø	Z Flutes	L OAL	Coating
7006-270190	UMMB 20090 x 03 S30 HMP700	0.90mm	2.70mm	3.00mm	2	38	HMP700
7006-270193	UMMB 20100 x 03 S30 HMB	1.00mm	3.00mm	3.00mm	2	38	Uncoated
7006-270194	UMMB 20100 x 03 S30 HMP700	1.00mm	3.00mm	3.00mm	2	38	HMP700
7006-270197	UMMB 20150 x 03 S30 HMB	1.50mm	4.50mm	3.00mm	2	38	Uncoated
7006-270198	UMMB 20150 x 03 S30 HMP700	1.50mm	4.50mm	3.00mm	2	38	HMP700
7006-270201	UMMB 20200 x 03 S30 HMB	2.00mm	6.00mm	3.00mm	2	38	Uncoated
7006-270202	UMMB 20200 x 03 S30 HMP700	2.00mm	6.00mm	3.00mm	2	38	HMP700
7006-270205	UMMB 20250 x 03 S30 HMB	2.50mm	7.50mm	3.00mm	2	38	Uncoated
7006-270206	UMMB 20250 x 03 S30 HMP700	2.50mm	7.50mm	3.00mm	2	38	HMP700
7006-270209	UMMB 20300 x 03 S30 HMB	3.00mm	9.00mm	3.00mm	2	38	Uncoated
7006-270210	UMMB 20300 x 03 S30 HMP700	3.00mm	9.00mm	3.00mm	2	38	HMP700

Pilot Drill for Centering & Spot Drilling with 120° Chamfering

UTILIS
u-hexalob

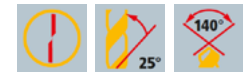
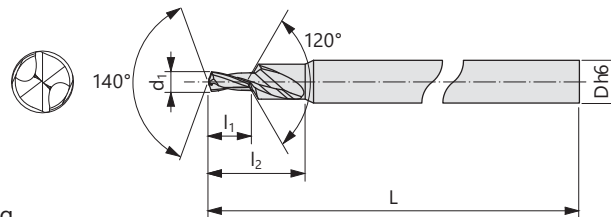

Symbols Key (Pages 4 & 5)

UMDT

Point relief: 4 facet, 140° S-point: self-centering

Item No.	Description	TORX®	d ₁ Flute Ø	d ₂ Flank Ø	l ₁ Flute Length	l ₂ Neck Length	D h6 Shank Ø	L OAL	Coating
7006-270227	UMDT 4-0090 x 0071 S30 HMP700	T4	0.90mm	2.00mm	0.71mm	2.70mm	3.00mm	38mm	HMP700
7006-270228	UMDT 5-0100 x 0089 S30 HMP700	T5	1.00mm	2.00mm	0.89mm	3.20mm	3.00mm	38mm	HMP700
7006-270229	UMDT 6-0120 x 0105 S30 HMP700	T6	1.20mm	2.35mm	1.05mm	3.80mm	3.00mm	38mm	HMP700
7006-270230	UMDT 7-0140 x 0105 S30 HMP700	T7	1.40mm	3.00mm	1.05mm	4.40mm	3.00mm	38mm	HMP700
7006-270231	UMDT 8-0162 x 0142 S30 HMP700	T8	1.62mm	3.00mm	1.42mm	5.50mm	3.00mm	38mm	HMP700
7006-270232	UMDT 10-0193 x 0145 S40 HMP700	T10	1.93mm	3.40mm	1.45mm	6.20mm	4.00mm	50mm	HMP700
7006-270233	UMDT 15-0231 x 0180 S40 HMP700	T15	2.31mm	3.95mm	1.80mm	7.40mm	4.00mm	50mm	HMP700
7006-270234	UMDT 20-0272 x 0215 S60 HMP700	T20	2.72mm	4.55mm	2.15mm	8.60mm	6.00mm	50mm	HMP700
7006-270235	UMDT 25-0312 x 0285 S60 HMP700	T25	3.12mm	5.10mm	2.85mm	10.20mm	6.00mm	50mm	HMP700
7006-270236	UMDT 30-0390 x 0350 S60 HMP700	T30	3.90mm	6.20mm	3.50mm	12.60mm	6.00mm	50mm	HMP700

End Mill Solid Carbide

Perfectly suited for milling the TORX® contour

UTILIS
u-hexalob

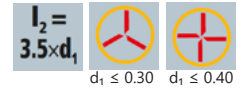
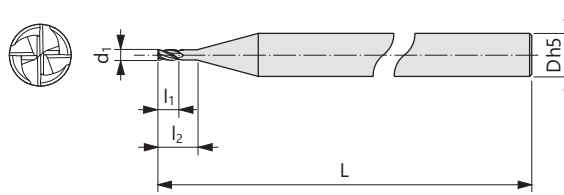

Symbols Key (Pages 4 & 5)

UMMT ... x 018 H035 ...

Item No.	Description	TORX®	d ₁ Flute Ø	l ₁ Flute Length	l ₂ Neck Length	D h5 Shank Ø	L OAL	Z Flutes	Coating
7006-270211	UMMT 30020 x 018 H035 S40 HMP600	T4	0.20mm	0.36mm	0.70mm	4.00mm	40mm	3	HMP600
7006-270212	UMMT 30025 x 018 H035 S40 HMP600	T5	0.25mm	0.45mm	0.90mm	4.00mm	40mm	3	HMP600
7006-270213	UMMT 30030 x 018 H035 S40 HMP600	T6 / T7	0.30mm	0.54mm	1.10mm	4.00mm	40mm	3	HMP600
7006-215784	UMMT 40040 x 018 H035 S40 HMP600	T8 / T10	0.40mm	0.72mm	1.40mm	4.00mm	40mm	4	HMP600
7006-270214	UMMT 40050 x 018 H035 S40 HMP600	T10 / T15	0.50mm	0.90mm	1.80mm	4.00mm	40mm	4	HMP600
7006-270215	UMMT 40060 x 018 H035 S40 HMP600	T15 / T20	0.60mm	1.08mm	2.10mm	4.00mm	40mm	4	HMP600
7006-270216	UMMT 40070 x 018 H035 S40 HMP600	T20 / T25	0.70mm	1.26mm	2.50mm	4.00mm	40mm	4	HMP600
7006-270217	UMMT 40080 x 018 H035 S40 HMP600	T25	0.80mm	1.44mm	2.80mm	4.00mm	40mm	4	HMP600
7006-270218	UMMT 40100 x 018 H035 S40 HMP600	T30	1.00mm	1.80mm	3.50mm	4.00mm	40mm	4	HMP600

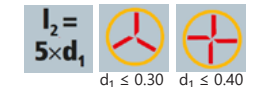
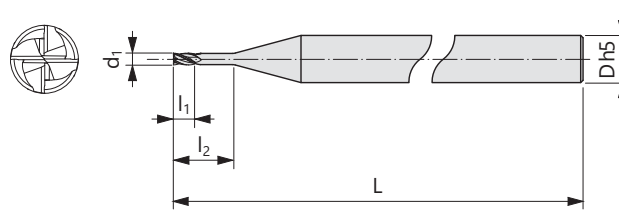

Symbols Key (Pages 4 & 5)

UMMT...x 018 H05...

Item No.	Description	TORX®	d ₁ Flute Ø	l ₁ Flute Length	l ₂ Neck Length	D h5 Shank Ø	L OAL	Z Flutes	Coating
7006-270219	UMMT 30020 x 018 H05 S40 HMP600	T4	0.20mm	0.36mm	1.00mm	4.00mm	40mm	3	HMP600
7006-270220	UMMT 30025 x 018 H05 S40 HMP600	T5	0.25mm	0.45mm	1.30mm	4.00mm	40mm	3	HMP600
7006-270221	UMMT 30030 x 018 H05 S40 HMP600	T6 / T7	0.30mm	0.54mm	1.50mm	4.00mm	40mm	3	HMP600
7006-270222	UMMT 40040 x 018 H05 S40 HMP600	T8 / T10	0.40mm	0.72mm	2.00mm	4.00mm	40mm	4	HMP600
7006-270223	UMMT 40050 x 018 H05 S40 HMP600	T10 / T15	0.50mm	0.90mm	2.50mm	4.00mm	40mm	4	HMP600
7006-215783	UMMT 40060 x 018 H05 S40 HMP600	T15 / T20	0.60mm	1.08mm	3.00mm	4.00mm	40mm	4	HMP600
7006-270224	UMMT 40070 x 018 H05 S40 HMP600	T20 / T25	0.70mm	1.26mm	3.50mm	4.00mm	40mm	4	HMP600
7006-270225	UMMT 40080 x 018 H05 S40 HMP600	T25	0.80mm	1.44mm	4.00mm	4.00mm	40mm	4	HMP600
7006-270226	UMMT 40100 x 018 H05 S40 HMP600	T30	1.00mm	1.80mm	5.00mm	4.00mm	40mm	4	HMP600